



February
25 Cents
Canada 30¢

Radio-Craft

HUGO GERNSBACK
Editor

How Bird Sounds are Recorded

See Page 462

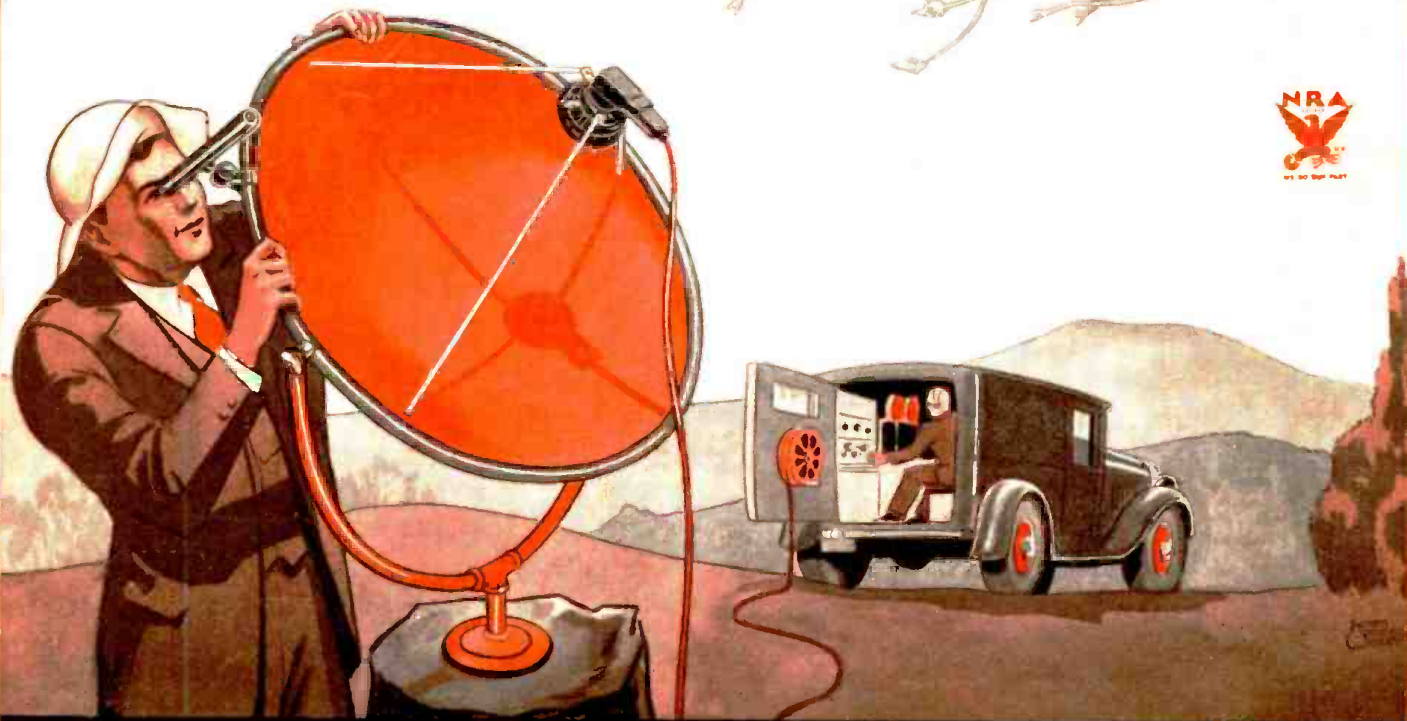

How to Make a Beginner's Short-Wave Radio Set – A D.C.-Line Tube Checker
Making a Voice-Operated Control – Building a "2B6"-Tube A. F. Amplifier

ANNOUNCING

A GOLDEN OPPORTUNITY FOR ALERT RADIO MEN IN THE NEXT GREAT INDUSTRY



PRE-PUBLICATION OFFER

\$4.00

THE idea of electricians, radio service men and other mechanically inclined men, servicing Air Conditioning and Refrigeration Units is self-evident and the thought has occurred to some untold thousands ever since air conditioning equipment has been installed in public auditoriums, theatres, studios, department stores, office buildings and manufacturing plants. The tremendously broad possibilities in this new industry are bound to give employment and success to men far-sighted enough to see its advancement and development. We quote an excerpt from Mr. Hugo Gernsback's editorial which appeared in the September, 1933 issue of *Everyday Science and Mechanics*:

"I advise young and progressive men to go into the air-conditioning business during the next few years because, this, without a doubt, is the coming industry in this country. Thousands of small firms will spring up, undertaking to air-condition private houses, small business offices, factories, etc. We are not going to tear down every building in the United States immediately. It will be a gradual growth; yet small installation firms will air-condition small houses, and even single offices in small buildings."

This is only partial proof of the certain success of this new field. Further assurance is that engineering schools have already added many important courses on air conditioning to their regular curriculum. Architects and building contractors are giving considerable thought to installation of this equipment in structures which are now being planned and built. The beginning of this business will probably be similar to the auto and radio industry, but in a few short years it will surpass these two great fields.

Official Air Conditioning Service Manual

352 Pages
Over 600 Illustrations
9" x 12" in Size
Flexible, Loose Leaf
Leatherette Cover



MAIL COUPON TODAY!

GERNSBACK PUBLICATIONS Dept. RC-234
96-98 Park Place, New York, N. Y.

Gentlemen: Enclosed you will find my remittance of Two Dollars for which you are to send me One Copy of the OFFICIAL AIR CONDITIONING SERVICE MANUAL, postage prepaid, as soon as it comes off the press. I am to pay the additional Two Dollars to postman when it is delivered. It is understood that the regular price of the book will be FIVE DOLLARS when it comes off the press, and I am now paying only a pre-publication price of Four Dollars.

Name

Address

City State

(Send remittance in form of check, money order or unused U.S. Postage Stamps. Register letter if it contains stamps or currency.)

The OFFICIAL AIR CONDITIONING SERVICE MANUAL is being edited by L. K. Wright, who is an expert and a leading authority on air conditioning and refrigeration. He is a member of the American Society of Refrigerating Engineers, American Society of Mechanical Engineers, National Association of Practical Refrigerating Engineers; also author of the OFFICIAL REFRIGERATION SERVICE MANUAL and other volumes.

In this Air Conditioning Service Manual nearly every page will be illustrated; every modern installation and individual part carefully explained; diagrams furnished of all known equipment; special care given to the servicing and installation end. The tools needed will be illustrated and explained; there will be plenty of charts and page after page of service data.

Remember there is a big opportunity in this new field and plenty of money to be made in the servicing end. There are thousands of firms selling installations and parts every day and this equipment must be cared for frequently. Eventually air conditioning systems will be as common as radios and refrigerators in homes, offices and industrial plants. Why not start now—increase your earnings with a full- or spare-time service business.

You have the opportunity to get your copy of the OFFICIAL AIR CONDITIONING SERVICE MANUAL today—at a saving of ONE DOLLAR. When the book comes off press, which will be March 15th, the price will be \$5.00 a copy. YOUR ORDER TODAY BRINGS YOU A COPY FOR \$4.00. POSTAGE PREPAID. This is our usual courtesy, pre-publication offer which enables us to determine the approximate print order for the first press run. Send us the coupon today, together with a deposit of \$2.00. When the book reaches you, you pay the other \$2.00.

Here are some of the chapter heads of the AIR CONDITIONING SERVICE MANUAL:

Contents in Brief

History of Air Conditioning; Fundamental Laws; Methods of Refrigeration; Ejector System of Refrigeration; Compression System of Refrigeration; Refrigerants; Lubricating Oils; Liquid Throttle Devices; Servicing Expansion and Float Valves; Servicing Refrigerating Systems; Control Devices; Thermodynamics of Air Conditioning; Weather in the United States; The Field of Air Conditioning; Insulating Materials; Heat Transmission Through Walls; Complete Air Conditioning Systems; Estimating Requirements for the Home, Small Store, Restaurant; Layout of Duct Systems; Starting Up a System; Operating and Servicing Air Conditioning Systems; Air Filtration, Ventilating and Noise Eliminating Devices; Portable Electric Humidifiers and Room Coolers; Automatic Humidifiers; Air Conditioning Units for Radiator Systems and Warm Air Systems; Central Conditioning Units, etc.

GERNSBACK PUBLICATIONS, INC.
96-98 Park Place New York, N. Y.

LEARN RADIO IN 10 WEEKS!

PAY FOR YOUR TRAINING AFTER YOU GRADUATE

I am making an offer that no other school has dared to do. I'll take you here in my shops and give you this training and you pay your tuition after you have graduated. Two months after you complete my course you make your first payment, and then you have ten months to complete your payments. There are no strings to this offer. I know a lot of honest fellows haven't got a lot of money these days, but still want to prepare themselves for a real job so they won't have to worry about hard times or lay offs.

I've got enough confidence in these fellows and in my training to give them the training they need and pay me back after they have their training.

If you who read this advertisement are really interested in your future here is the chance of a life time. Mail the coupon today and I'll give you all the facts.



A scene in the big, busy Radio Shops at Coyne. Here you see fellows working on real Radios—not reading about them from books or lessons. This is THE way to prepare for the big-money field of Radio!

TELEVISION *and* TALKING PICTURES

Television is already here! Soon there'll be a demand for THOUSANDS of TELEVISION EXPERTS! The man who learns Television now can have a great future in this great new field. Get in on the ground-floor of this amazing new Radio development! Come to COYNE and learn Television on the very latest, newest Television equipment. Talking Picture and Public Address Systems offer opportunities to the Trained Radio Man. Here is a great new Radio field just beginning to grow! Prepare NOW for these wonderful opportunities! Learn Radio Sound Work at Coyne on actual Talking Picture and Sound Reproduction equipment.

PREPARE NOW and be ready for Radio's many opportunities

Forget pay-cuts—lay-offs—unemployment! Don't be tied down to an untrained man's future. You NEED TRAINING IN A FAST-GROWING MONEY-MAKING TRADE. Here's your chance of a lifetime to get it! Hundreds of opportunities now open in Radio. My sensational offer, explained below, makes it possible for you to START AT ONCE!

The right way to learn Radio is the Coyne way—not by books, but by actual, practical work on actual Radio, Television and Sound equipment. Here at Coyne you'll service and operate scores of modern Radio receivers, huge Broadcasting equipment, late type Television apparatus, Talking Picture machines, Code transmitters and receivers, etc. In 10 weeks you can step into a REAL JOB, leading to a salary of \$50 a week and UP!

ALL PRACTICAL WORK At COYNE in Chicago

ALL ACTUAL, PRACTICAL WORK. You build radio sets, install and service them. You actually operate great Broadcasting equipment. You construct Television Receiving Sets and actually transmit your own Television programs over our modern Television equipment. You work on real Talking Picture

machines and Sound equipment. You learn Wireless Operating on actual Code Practice apparatus. We don't waste time on useless theory. We give you the practical training you'll need—in 10 short, pleasant weeks.

MANY EARN WHILE LEARNING

You get Free Employment Service for Life. And don't let lack of money stop you. Many of our students make all or a good part of their living expenses while going to school and if you should need this help just write to me. Coyne is 33 years old. Coyne Training is tested—proven beyond all doubt. You can find out everything absolutely free. Just mail coupon for my big free book!

H. C. LEWIS, Pres. RADIO DIVISION Founded 1899
COYNE ELECTRICAL SCHOOL
500 S. Paulina St., Dept. 24-8H Chicago, Ill.

Mail Coupon Today for All the Facts

H. C. LEWIS, President
Radio Division, Coyne Electrical School
500 S. Paulina St., Dept. 24-8H Chicago, Ill.

Dear Mr. Lewis: Send me your big FREE Book; details of your FREE Employment Service; and tell me all about your special offer of allowing me to pay for training on easy monthly terms after graduation.

Name.....

Address.....

City.....State.....



HUGO GERNSBACK, Editor-in-Chief
C. W. PALMER Associate Editor R. D. WASHBURNE Technical Editor



CONTENTS OF THE FEBRUARY, 1934, ISSUE

VOLUME V NUMBER 8

Editorial: What About Television?..... Hugo Gernsback	453
The Radio Month in Review.....	454
Recent Radio Developments—Illustrated.....	456
WLW On the Air With 500 Kw.....	457
Latest in Radio.....	458
International Radio Review.....	460
How the Sounds of Birds Are Recorded on Film and Disc..... Gene A. Day	462
An Airplane Dual-Range Receiver and 5 Meter Transceiver..... R. D. Washburne and N. H. Lessem	464
How to Make the Beginner's I Tube Short-Wave Set..... Francis R. Harris	466
Short Cuts in Radio.....	468
Making a 9 Tube Home-Built A.C. T.R.F. Set..... Oscar Block	470
An Introduction to Radiodynamics..... Thomas W. Benson	472
Readers' Department.....	473
How to Make a Home-Recording Control Unit..... Joseph Leeb	474
Construction Details of a Novel 9 Tube All-Wave Superheterodyne..... S. Miller	475
Servicing the "Talkies" Part IV..... Aaron Nadell	476
A 110 V., D.C. Tube-Checker Attachment..... L. W. Haase	477
Operating Notes..... Bertram M. Freed	478
Constructing a "2B6" Amplifier..... F. V. Shortt	479
RADIO SERVICE DATA SHEETS:	
No. 107—Wurlitzer Lyric Model SW88 (SW80 Chassis) 8 Tube All-Wave Superheterodyne.....	480
No. 108—Stromberg-Carlson Nos. 55 and 56 Telek-tor-et 8 Tube Superheterodyne.....	481
Constructing a 6 V. D.C. and 110 V. A.C. Duo-Channel 50 W. P.A. System..... Louis Gancher	482
Information Bureau.....	484
Book Review.....	506

IN OUR NEXT FEW ISSUES:

DYNATRON CIRCUITS. Many explanations have been printed telling how the vacuum tube works as a dynatron generator of electrical oscillations. However, these descriptions have either been notably lacking in certain respects or they cover the subject from such a hypothetical mathematical nature that Mr. Average Radio Man is lost in the first paragraph and thus gains nothing by his diligent study. However, we have at last obtained a description of the dynatron phenomenon that is non-mathematical in nature and yet covers the subject.

AN ALL-PURPOSE SERVICE OSCILLATOR. This highly useful unit makes use of the versatile characteristics of the 6F7 tube. Some of the factors that make this unit superior for the Service Man are as follows: compact; A.C.-D.C. operation; I.F., R.F. and short-wave coverage; pure audio modulation; and flexible control of high-frequency and audible-frequency output.

RADIO-CRAFT is published monthly, on the fifth of the month preceding that of date; its subscription price is \$2.50 per year. (In Canada and foreign countries, \$3.00 a year to cover additional postage.) Entered at the post office at Mt. Morris, Ill., as second-class matter under the act of March 3, 1879.

Text and illustrations of this magazine are copyright and must not be reproduced without permission of the copyright owners. We are also agents for *WONDER STORIES* and *EVERYDAY SCIENCE AND MECHANICS*. Subscription to these magazines may be taken in combination with RADIO-CRAFT at reduced Club rates. Write for information.

Copyright 1934. Continental Publications, Inc.

HUGO GERNSBACK, President I. S. MANHEIMER, Secretary
Published by Continental Publications, Inc. Publication office: 404 N. Wesley Ave., Mount Morris, Illinois. Editorial and Advertising Office: 96-98 Park Place, New York City. Chicago Advertising Office: L. F. McClure, 919 North Michigan Avenue, Chicago, Ill. Western Advertising Office: Loyd B. Chappell, 511 So. Alexandria St., Los Angeles, Calif.

London Agent: Hachette & Cie., 3 La Belle Sauvage, Ludgate Hill, E.C. 4
Paris Agent: Hachette & Cie., 111 Rue Reamur Australian Agent: McGills Agency 179 Elizabeth St., Melbourne

I will Train You at Home



Here's Proof



Service Manager Earns \$200 Month

"As Radio Service Manager for Sterchi's four Nashville Stores, my earnings are around \$200 a month. My N.R.I. training enables me to keep our customers satisfied." E. H. Leftwich, Sterchi Bros. Stores, Inc., Nashville, Tenn.



\$120 a Month In Spare Time

"I'm servicing from 3 to 5 sets daily in spare time and average \$120 a month from my Radio work. I still hold my regular day job. I owe my success to N.R.I." A. E. Farmer, 1012 Denison St., Muskogee, Okla.



Owes a Lot to N. R. I.

"After finishing my tenth lesson, I started on my first job. After that, jobs came rolling in and I found myself with a surplus of money with which to continue paying for my Course. My first year's record was 108 Radio jobs. I have cleared \$2,305 to date in spare time."

John Hearl
66-53 Jary Ave.
Maspeth, L. I., N. Y.

in your spare time to fill a **GOOD JOB** in Radio

Get away from disagreeable jobs with no future. From skinny, little pay envelopes. From skimming along, just barely getting by, but not getting ahead. **DON'T PUT UP WITH THEM ANY LONGER.** Get into a field with a future. Act today to put yourself ahead. Mail the coupon for my free 64-page book that tells how you can train at home in your spare time to be a Radio Expert; about my Course that doubles and triples the pay of many who take it. **MAIL THAT COUPON NOW** and take the first step toward a real future.

Free Book Tells How Mail Coupon!

Real Opportunities Ahead in Radio for Trained Men

It's hard to find a field with more opportunity awaiting the trained man. Why in 1932—the worst year of the depression—the Radio Industry sold \$200,000,000 worth of sets and parts! Manufacturers alone employed nearly 100,000 people! About 300,000 people worked in the industry. 1932 broadcasting revenue was the biggest in history. It's a gigantic business, even in the worst business years! And look what's ahead! Millions of sets becoming obsolete annually. 17,000,000 sets in operation that need servicing from time to time! Over 600 great broadcasting stations furnishing entertainment and news to 100,000,000 people. These figures are so big that they are hard to grasp! Yet, they are all true! Here is a new industry that has grown into a commercial giant. No wonder great business leaders predict a brilliant future for this great and growing business.

Get Into This Field With a Future

There's opportunity for you in Radio. Its future is certain. Television, short wave, police Radio, automobile Radio, loud speaker systems, aircraft Radio—in every branch, developments and improvements are taking place. Here is a real future for thousands and thousands of men who really know Radio. Get the training that opens the road to good pay, and success! Send me the coupon now, and get full particulars on how easy and interesting I make learning at home. Read the letters from graduates who are today earning real money in this fascinating industry.

Many Make \$5, \$10, \$15 a Week Extra in Spare Time Almost at Once

My book also tells how many of my students made \$5, \$10, \$15 a week extra in spare time, soon after they enrolled. I give you plans and ideas that have made good spare-time money—\$200 to \$1,000 a year—for hundreds of fellows. My Course is famous as "the one that pays for itself."

Money Back if Not Satisfied

I am so sure that N.R.I. can train you satisfactorily that I will agree in writing to refund every penny of your tuition if you are not satisfied with my Lessons and Instruction Service upon completion. You'll get a copy of this Agreement with my book.

64-page Book of Information Free

Get your copy today. It's free to any ambitious fellow over 15 years old. It tells you about Radio's spare time and full time job opportunities; it tells you all about my Course; what others who have taken it are doing and making. Find out what Radio offers YOU without the slightest obligation. **MAIL THE COUPON NOW.**

J. E. SMITH, President
National Radio Institute, Dept. 4BX
Washington, D. C.

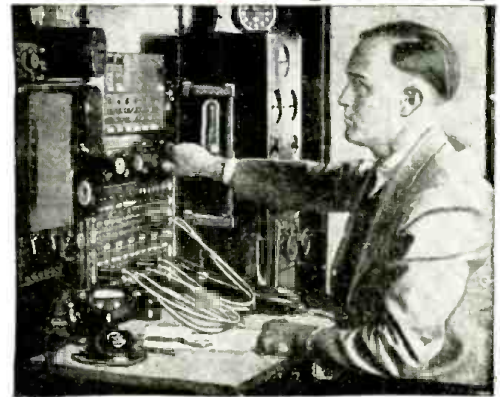

SPECIAL FREE OFFER



Act now and receive in addition to my big free book, "Rich Rewards in Radio," this Service Manual on D. C. A. C., and Battery operated sets. Only my students could have this book in the past. Now readers of this magazine who mail the coupon will receive it free. Overcoming hum, noises of all kinds, fading signals, broad tuning, howls and oscillations, poor distance reaction, distorted or muffled signals, poor Audio and Radio Frequency amplification and other vital Service information is contained in it. Get a free copy by mailing the coupon below.

SPECIAL Radio Equipment for Broad Practical Experience Given Without Extra Charge

My Course is not all theory. I'll show you how to use my special Radio equipment for conducting experiments and building circuits which illustrate important principles used in such well-known sets as Westinghouse, General Electric, Philco, R. C. A., Victor, Majestic, and others.

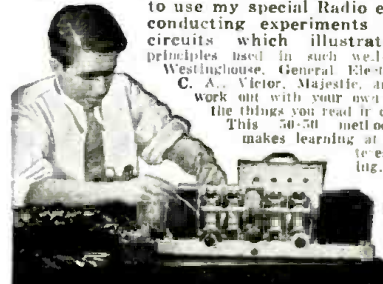

You work out with your own hands many of the things you read in our lesson books. This 50-50 method of training makes learning at home easy, interesting, fascinating, intensely practical. You learn how sets work, why they work, and how to make them work when they are out of order.

I have doubled and tripled the salaries of many Find out about this tested way to BIGGER PAY



FILL OUT AND MAIL THIS COUPON TODAY

J. E. SMITH, President
National Radio Institute, Dept. 4BX
Washington, D. C.

Dear Mr. Smith, I want to take advantage of your Special Offer. Send me your manual "Trouble Shooting in D.C., A.C. and Battery Sets" and your book "Rich Rewards in Radio," which explains Radio's Opportunities for bigger pay and your method of training men at home in spare time. I understand this request does not obligate me. (Please print plainly)

Name _____ Age _____
Address _____
City _____ State _____ M

The Famous Course That Pays For Itself

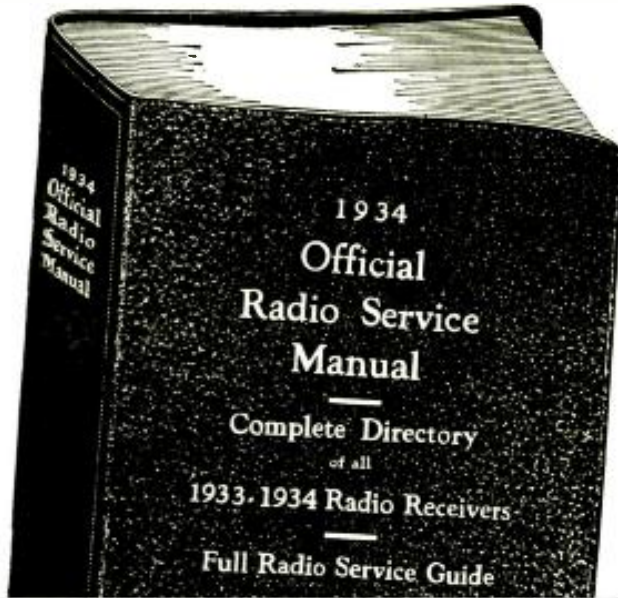

400 Pages
 Over 2,000 Illustrations
 9 x 12 Inches
 Flexible, Looseleaf
 Leatherette Cover

\$3.50

Reg. List Price

There's plenty of Servicing Material

in the NEW 1934 Manual

THE necessity of GERNSBACK Manuals in the radio field has been shown by the fact that the total sales of the first three OFFICIAL RADIO SERVICE MANUALS, including the new CONSOLIDATED EDITION, now exceed 80,000 copies. Radio Service Men and others engaged in various branches of radio know the importance of such books, and how they must depend upon them for reliable information. Whether for public-address work, tube information or a circuit diagram, the material needed is certain to be found in one of the OFFICIAL RADIO SERVICE MANUALS.

In preparing this new edition many of the outstanding problems of the Service Men have been considered—methods of servicing, the new equipment constantly needed to cope with new tubes and sets, and the other fields of radio, such as public-address systems, short waves, auto radio and others.

The illustrations in the 1934 Manual are more explicit than before; inasmuch as the diagrams are not limited to the schematic circuit, but other illustrations show the parts layout, positions of trimmers, neutralizers, etc. There are hundreds of new circuits included, and not one from any previous editions of the manuals has been repeated. *This we unconditionally guarantee.*

As in previous years, the 1934 Manual also includes a FREE QUESTION AND ANSWER SERVICE. In each book will be found 25 coupons, which entitle you to free consultation on any radio service topic. These coupons give you a complete mail service—questions on servicing and operating any set or circuit are answered promptly and accurately by the editors. Remember that, at the regular rate of 25¢ per question which is usually charged by radio magazines, this service alone is worth \$6.00. And for the Manual, we charge only \$3.50.

It is quite evident that the 1934 Edition of the OFFICIAL RADIO SERVICE MANUAL is a decided improvement over previous volumes.

ORDER YOUR COPIES NOW

It is important to every Radio Service Man and Dealer to get his copy of the 1934 OFFICIAL RADIO SERVICE MANUAL now. The new book will prove itself to be invaluable as those volumes of previous years.

No need to delay sending us your order—the 1934 MANUAL, like its predecessors, is a necessity in your business. We strongly advise you to order your copy today.

GERNSBACK PUBLICATIONS, INC.
 96-98 Park Place New York, N. Y.

Contents of the 1934 Manual in Brief

- Diagrams and service notes, more complete than ever before in any MANUAL. Not merely the schematic hook-ups will be found, but chassis drawings showing parts layouts, positions of trimmers, neutralizers, etc.
- Voltage readings for practically all sets, as an aid in checking tubes and wiring.
- All values of intermediate-frequency transformers used in superheterodynes, with the manufacturers' own suggestions as to correct balancing.
- Detailed trouble-shooting suggestions and procedure as outlined by the manufacturers' own engineers—in other words, authentic "dope" right from headquarters.
- Values of all parts indicated directly on all diagrams.
- Section for reference to A.C.-D.C. cigarbox midgests.
- Section for reference to public-address amplifiers.
- Section for reference to short-wave receivers.
- Section for reference to remote-control systems.
- A complete compilation of radio tube data, covering both the old and the many new types.
- Section devoted to test equipment, analyzers, etc., with full diagrams and other valuable information.
- A complete list of American broadcast stations with their frequencies in kilocycles; extremely useful in calibrating and checking test oscillators and in calibrating receivers.
- Free Question and Answer Service, the same as in our last two Manuals.
- No theory; only service information in quickly accessible form.
- Absolutely no duplication of any diagrams; nothing that appeared in any of the previous Manuals will appear in the 1934 MANUAL. This we unconditionally guarantee.
- A handy, easily-consulted master index making it easy for you to find almost anything pertaining to your service problem instantly. This index includes all the diagrams published in all the previous GERNSBACK Manuals, as well as the 1934 diagrams. A big convenience and time saver!

Clip—Mail This Coupon Today

GERNSBACK PUBLICATIONS, Inc.
 96-98 Park Place, New York, N. Y.

Gentlemen: Enclosed you will find my remittance of \$3.50 for which you are to send me, Postage Prepaid, One Copy of the 1934 OFFICIAL RADIO SERVICE MANUAL. [Send remittance by check or money order; or register letter if it contains cash, currency or unused U. S. Postage stamps.]

Name

Address

City State

RC-234



"Takes the Resistance Out of Radio"

Editorial Offices: 96-98 Park Place, New York, N. Y.

HUGO GERNSBACK, Editor

Vol. V., No. 8, February, 1934

WHAT ABOUT TELEVISION?

An Editorial by HUGO GERNSBACK

TELEVISION has now been with us for a good many years. Baird in England demonstrated television about 1926; while Jenkins, in this country, had achieved some measure of success with the first crude television apparatus in the year 1922.

Strange as it may seem, very little *scientific progress* has been made in television from that time on. It is true, that some of the mechanics of the scanning apparatus have been improved; we have better neon tubes; and we are enabled to get a larger and clearer image today than was possible five years ago. Yet television has not "arrived." The man in the street asks the question—and he asks it frequently—"what about television—what is happening? Is it true that our large corporations are deliberately withholding television on account of the depression? Has television been perfected, etc.?"

To these questions, it might be answered that none of our large radio companies are holding back television, nor has the art been perfected sufficiently to put it on a par with present-day home radio. All of our big radio interests have been toying with television; but whatever has been produced is still in the laboratory stage.

It is true that, by means of the mechanical scanning disc, you can, today, obtain a fair-to-middlin' image, providing certain "ifs" are answered. In the first place, the television transmitter must be "tied in" with the A.C. lighting system that supplies the current to those who have receiving instruments. If you live in a different district, where your electric house current is not tied in with the system that also supplies the transmitter, you are out of luck; because your images will not synchronize properly, unless you go to an endless amount of trouble and are, in fact, a radio engineer.

In other words, if you are located on a farm or if you are in a suburban home, away from the network which supplies the current to television transmitting stations, you will have trouble. If you are in a district which has direct current, you are equally out of luck.

Secondly; so far, the images have been rather small, too small in fact, for comfortable viewing and enjoyment of a presentation. Images a foot square are not clear.

Finally, as I have pointed out many times, the idea of a mechanical scanning disc is not the solution of television; this compares to the crystal stage of radio development and, in my estimation, television will never amount to anything until we have some other, non-mechanical form of television set.

This brings us to the cathode-tube television scanner, from which much has been expected but little has been accomplished so far.

We have pretty good cathode-tube scanning apparatus today; but they are still expensive, cumbersome, and do not give the results that are expected of them; and, while the cathode tube may be *one* answer to television, I do not believe that it is the final answer.

I pointed out years ago that television research scientists and engineers seem to be on the wrong track, as far as television is concerned. By that, I meant that they are still clinging to the old school of "scanning." This school teaches that you must break up your image into thousands and millions of little points, which you transmit by translating them into electrical impulses and then re-assemble at the receiver; where the reverse action is brought about so that you can view the image.

This scanning idea, to my mind, is all wrong, and totally unnecessary. When the final television invention comes along, one which may be likened to the radio tube of today as compared with the radio crystal of yore, it will be found that the scanning idea is conspicuous by its absence.

Some thirty million years ago, nature invented the first real television machine which, so far, has not been duplicated by man. I refer, of course, to the animal eye, which has been in existence on this planet for million of years, and is open for study by all television aspirants.

The animal eye (which, of course, includes the human eye) is almost a perfect television receiver and transmitter. Not only does it receive an image from the outside world by means of light rays and then transmit it through the optic nerve to the brain, but it goes the television engineer several steps better; because, in the first place, the eye gets along marvelously well WITHOUT ANY SCANNING MECHANISM, but the image is received and transmitted in colors as well.

And, while it may be true that colors do not exist in nature, but are only a psychological effect in the mind; yet if, by electrical means, you can duplicate the living eye's television machine, you will then also be able to transmit and receive color impulses so that the human eye can receive them. It will be noted that the human eye "takes in" an image all at once; that is, AN IMAGE IN ITS ENTIRETY, IN ONE INSTANT. Even a fast-moving automobile or bird requires no scanning by the human eye. The entire automobile or bird is transmitted to the retina, exactly as a photographic camera receives the entire image on its light-sensitive plate in a fraction of a second.

This would prove conclusively that it is possible to have television without the scanning idea; but, of course, there remains as yet to be invented, an instrumentality to achieve this result. Some engineers will probably call me to order and point out that, if I will supply them with several million conductive lines between the transmitter and receiver, they also can televise without scanning; because in the human eye there are actually millions of nerves which connect the retina with the brain, all these millions of nerves being enclosed in what we call the optic nerve. It has been found that each strand leading from the rods and cones of the retina is separate and distinct, being in fact a separate "conductor."

While I am aware of all this, the solution need not be as difficult as may be thought. Take, for instance, a telephone diaphragm. This single 2¼ in. black iron disc finds no difficulty in transmitting simultaneously thousands of different kinds of sounds that you can instantly recognize in the telephone or in your loudspeaker; yet you have but two conductors which connect the telephone transmitter and receiver.

In front of a loudspeaker, and listening to a symphonic orchestra, a finely-trained musical ear has no difficulty in picking out all of the musical instruments. And you, yourself, have no difficulty in recognizing, over the phone, the voice of a friend out of several hundreds others that may talk to you daily. Yet, the telephone receiver does no scanning; it does all these things with a single instrumentality. The telephone diaphragm is the counterpart of the ear, and that of the human eye is the missing link in television today. The final instrument which will solve the problem will be so simple that it would astonish us, today; just as Bell's telephone receiver seems absurdly simple from an electrical viewpoint, once you know the trick.

The RADIO MONTH in

EUROPE RE-TUNES



BRUSSELS' MASTER WAVEMETER
Bitter experience showed that central control was needed.

TO avoid a repetition of the chaos that followed the inauguration of the Prague Plan six years ago in Europe, the *Union Internationale de Radiodiffusion* has devised an elaborate scheme to effect a smooth change-over to the Lucerne Plan, on the fourteenth and fifteenth of this month (January). Apparently Europe has patched up at least a few of the differences brought out at the recent meeting at Amsterdam (*RADIO-CRAFT*, January 1934, page 391).

All Europe's stations will cease transmission at or before 11 P.M., G.M.T., on January fourteenth. Then, one by one, according to special schedules the stations will resume broadcasting on their new wavelengths. The accuracy of the re-tuning will be checked systematically by one of the 7 official control points.

At these points, special, accurate wavemeters will be used to check the stations within their individual groups. These seven points are: Brussels, Ber-

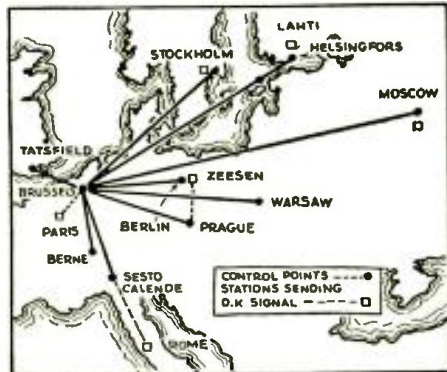

THE NETWORK FOR RETUNING EUROPE
To avoid the chaos which followed the Prague Plan.

lin, Prague, Helsinki (Sweden), Mojaisk (U. S. S. R.), Sesto Calenda (Italy), and Stockholm. The stations in the Brussels category are shown in the map below.

It may be wondered why each station does not change its wavelength according to its own wavemeter. However, bitter experience following the Prague Plan showed that much more rigid control was necessary. It appears that the wavemeters in the majority of European broadcast stations were of doubtful veracity.

JIMMY WALLINGTON WINS DICTION AWARD

AS Walt Winchell might say—an orchid to blue-eyed Jimmy Wallington who takes his place alongside Milton Cross, Alwyn Bach, John Holbrook and David Ross as the winner of the metal awarded each year for "good diction on the radio" by the American Academy of Arts and Letters.

Six-foot Jimmy came into prominence during the stay of the first Byrd expedition at Little America, when he acted as announcer to the special programs broadcast to Antarctica. Later, he achieved some success as a commentator at broadcasts of special events—and then came Eddie Cantor.



JIMMY WALLINGTON'S NEW MEDAL
Cantor's "straight man" annexes this year's diction award.

As "straight man" for the Cantor programs, Jimmy came into the full glare of the "lime light" and apparently he has come out with colors flying.

While we have no wish to "put a wet blanket" on friend Jimmy's achievement, it is strikingly evident that the selection of the "best" announcer is made entirely upon the personal opinions of the 60 to 100 judges on the following basis—pronunciation, articulation, tone quality, accent and cultural effort.

Absolutely no effort is made to verify

their selection by scientific methods. There are a number of accurate ways to check the quality of the voice, by waveform analysis, by direct comparison by means of reproducing devices, etc. The editor wonders why, in this day of scientific accuracy, a more reliable system is not chosen by the American Academy of Arts and Letters.



GEORGE F. MCCLELLAND
He quit NBC to start his own national chain.

BROADCAST CHAINS GALORE

SINCE the sad demise of the Amalgamated Broadcasting System, Ed Wynn's pride and joy, national networks have been springing up like mushrooms. At least three newcomers in the "network market" with national ambitions have been started.

The first of these projects which has come to our attention, and probably the most promising, is being formed by veteran George F. McClelland, one-time vice-president of NBC. In answer to inquiries at Mr. McClelland's office, the editor was informed that "Broadcasting Stations Corporation" which is the high-faluting name selected by directors of the new chain, does not expect to start full commercial operations until fall.

The second network is a remnant of the "Fire Chief's" chain, and consists of four stations of that late lamented group and one other station, who are starting very inauspiciously by trading programs. Evidently they learned a lesson

REVIEW

Radio is now such a vast and diversified art it has become necessary to make a general survey of important monthly developments throughout the field. RADIO-CRAFT analyzes these developments, and presents here a review of those items which are of interest to all.

from the high-pressure publicity in their Amalgamated experience.

The third chain (the owners of which admit that they have network aspirations) is associated with no less a national character than jovial former Gov. Al Smith. Al went seriously into this thing which he jocularly calls "rad-dio" when he and a group of wealthy and socially prominent young business men of New York leased the facilities of station WMCA, after a little argument with Czar Lafount.

Dolph, Chief of the radio division of the Bureau of Public relations of the National Recovery Administration, says: "compliance with the code will increase payrolls in the broadcasting industry \$1,328,000 yearly; 765 people will be re-employed and this number will represent a 350 increase over any previous high in employment."

And from another source, we learn that organized labor is making a drive on the radio industry, both in its broadcasting and its manufacturing aspects, to introduce unionization. It is claimed that wages are too low in the manufacturing end, and to enable "collective bargaining" union agents are pressing their plans upon employes outside the factories. The pay being higher in the broadcasting end, it is maintained that it should be even better, as proposed in the code for broadcasters.

and now radiates about 100 to 120 kw.

An interesting feature of the transmitter is the antenna system (which is illustrated here). It consists of a half-wave aerial familiar to our readers (RADIO-CRAFT, September 1931, page 269). However, another 420-ft. tower is used as a reflector so that the signals are sent out mainly to the west; 36, 10-foot masts support the counterpoise.

NEW YORK GOES RADIO TAXI MAD



ONE OF NEW YORK'S RADIO TAXIES
Owners of non-equipped hacks are using large "hankies."

LAST month, Radio Fleet Owners, Inc., put on the streets of New York, 2,000 taxis, all radio-equipped. The bright gray taxis immediately took New York by storm, and so anxious is the New York public for radio in their taxicabs that it promptly deserted all other taxicabs for the new radio taxicabs which now are doing a landoffice business.

The radio receiver used in these taxis is the usual Philco Transitone, installed below the taxi-meter in the cab. The loudspeaker is located on the inside section dividing passenger and driver, coming flush with the dividing wall, and faces the passenger. A small dial, with two controls, likewise faces the passenger. The quality of the sets that work is surprisingly good.

There remain, however, many bugs to be ironed out because, of six cabs which we hired in one week, two gave no radio reception due to open wires, blown tubes, etc. The taxi drivers keep the radio set going twenty-four hours a day, and even when they have no passengers, the radio goes full blast to attract prospective victims.

This is not according to Hoyle, because the radio set is only supposed to be switched on when the taximeter flag is pulled down. But the foxy drivers push a pin in the two wires that go to the flag, thus closing the circuit!

(Continued on page 485)

HAIL TO VIENNA'S NEW STATION

AND now comes news of a new super-power station—Austria's most powerful—being located on Bisamberg, an insignificant hill situated about half an hour from capital Vienna.

This transmitter is the first to use the 300 kw. tubes developed by telefunken. The station operates on 517 meters



VIENNA'S MAMMOTH BROADCASTER
Hear Europe group as "Wien" blankets the ether.



WE KILL OUR ART

RADIO-CRAFT modestly suggests that broadcasters adopt the above "eagle" as more appropriate than the standard blue eagle.
© by RADIO-CRAFT

RADIO'S BLUE EAGLE

RADIO set and parts manufacturers can now watch the radio broadcasters staggering along under their very own NRA code. The broadcasters (who were not included in the electrical code with the rest of the industry) have had a free hand up to this time, but have now come under a special code, and according to reports, they are not well pleased with it.

The reaction of the NAB (officially worded National Association of Broadcasters) is that the code of fair competition proposed by the National Recovery Administration, will increase expenses out of all bounds, and at a time when the broadcast business cannot be said to be on a breaking-even basis.

In a letter to RADIO-CRAFT, William B.

RECENT RADIO DEVELOPMENTS

— ILLUSTRATED



In the four photos above are shown details of the colossal installation at Radio City.

IN THE development of equipment installed at the Radio City home of NBC, many innovations have been incorporated to facilitate handling the 85 stations in the chain and the 35 studios at the headquarters. The four views above show some of the details of the installation. At 1 is a section of the control board from which the large dynamos supplying the power for the coast-to-coast networks, are controlled. The photo at 2 shows the "nerve-center" of the entire system. At this console, any desired studio, or station associated with NBC can be connected into the network. To prevent any possible failure of the power supply system, the emergency installation shown in 3 has been installed.

John McCormick (center) famous Irish tenor is shown at 4 looking over the power plant at Radio City, through which flows the current that carries his voice to many thousands of listeners each Wednesday evening.

Below (5) is shown the interior view of a new fixed-frequency transmitter designed for police broadcasting, on frequencies between 1,500 and 3,000 kc. The transmitter is rated at 250 W. and is designed to cover cities up to one million population.

At 6 is shown a photo of Macy's famous Thanksgiving Day parade. This year, the fantastic helium-filled animals were "sound animated" by the use of disguised sound trucks.

Left: — Police transmitter; right — Tony Sarg's "talking animals."

WLW ON THE AIR WITH 500 KW.

A NEW EXPERIMENT IN SUPER-POWER BROADCASTING

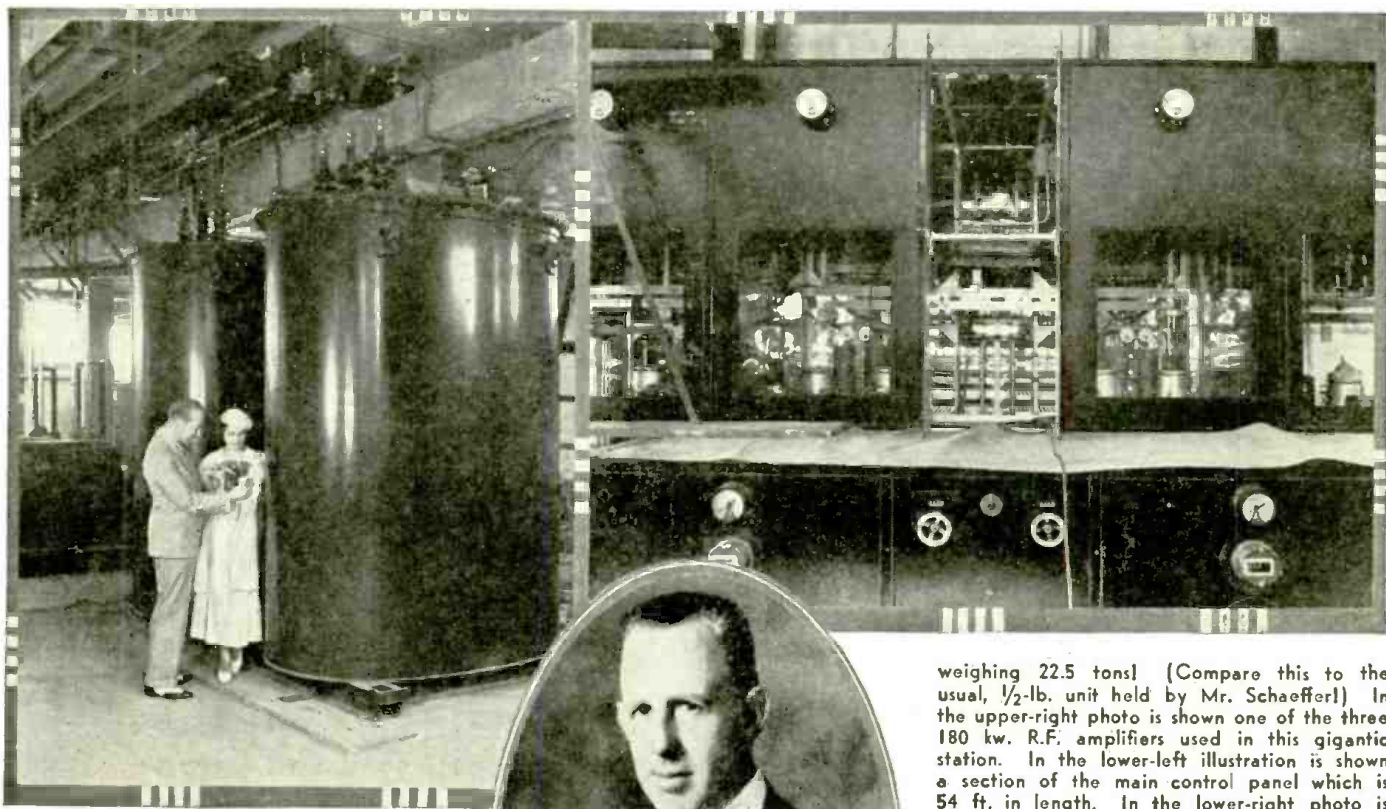

Radio broadcasting has developed through a series of steps from the first crude low-power transmitters used in the early experiments with the broadcasting of entertainment to the present highly complex and efficient transmitters. Through these gradual advancements, the Cincinnati station WLW, has often been identified as a pioneer. And now, the owners of this station are building a new transmitter, revolutionary in design and having a power output ten times greater than the previous maximum used in this country! In the upper-left photo are shown two oil-filled audio transformers, each

weighing 22.5 tons! (Compare this to the usual, 1/2-lb. unit held by Mr. Schaeffer!) In the upper-right photo is shown one of the three 180 kw. R.F. amplifiers used in this gigantic station. In the lower-left illustration is shown a section of the main control panel which is 54 ft. in length. In the lower-right photo is a view of the transmitter building and the 830 ft. vertical half-wave antenna. Powell Crosley, Jr., president and founder of Crosley Radio Corp., operators of WLW, WSAI and WBXAL, is shown in the central view. (Continued on page 503)

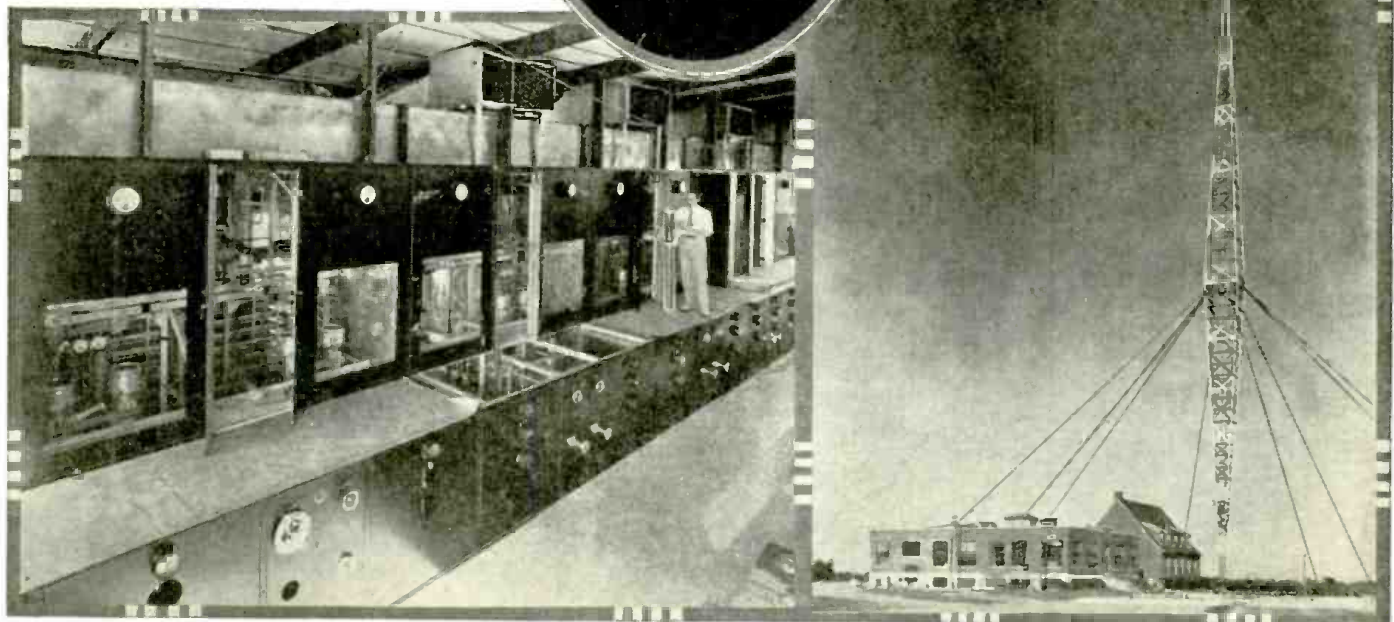

THE LATEST RADIO EQUIPMENT



A noise-locating unit (No. 389).

NOISE LOCATOR

THIS portable noise locator has been designed to meet the need of public utilities engineers and Service Men for a medium-priced unit. It measures only 12 x 12 x 7½ ins. high and weighs 21 lbs. when ready for operation.

The equipment includes a receiver with a sensitivity of 2 microvolts absolute, flat over the range of 1,500 to 500 kc.; a collapsible steel rod antenna; headphones; and the necessary batteries.

Visual and audible indications are afforded by the noise intensity meter and the phones. Ideal for use in the field.

TUBE-TEST ADAPTER

THE unit shown below is used for testing tubes having high filament voltage requirements in test units which do not have facilities for them.

It consists of a cylindrical case which is plugged into the type 24 tube socket—a rotary switch selects the correct filament voltage.

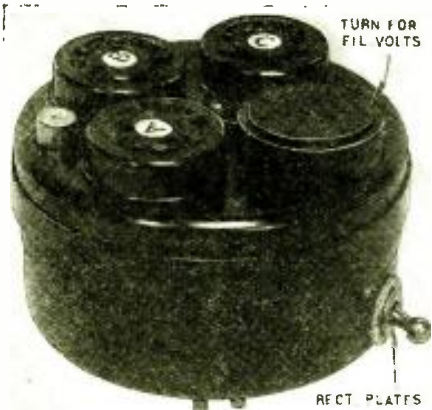

Tube tester adapter (No. 390).



A unit for testing high V. filament tubes. High-frequency speaker (No. 391)

HIGH-FREQUENCY REPRODUCER

THE speaker illustrated above permits reproduction up to 9,000 cycles for "wide range" talkies equipment. Couples to the existing, "standard" reproducer without a filter network.

MIDGET TRANSFORMERS

A NEW line of midget transformers for mike input, interstage coupling and output has just been introduced. They are 1¼ x 1¼ x 1¼ ins. high and have a high efficiency due to the use of special materials. Weigh only 8 oz.

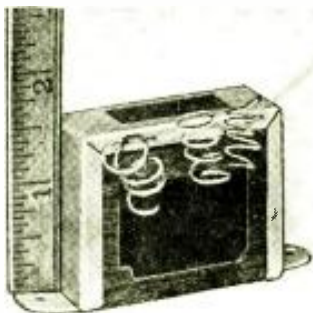

Above, a new line of midget coupling transformers for amplifier use (No. 392).

Right, a combined radio receiver and cocktail bar for the home (No. 394).

The set shown on the right includes a well-known chassis which is mounted in the special cabinet. This cabinet is equipped with rollers so that the radio set and "bar" can be conveniently moved from room to room.



A.C.-D.C. hearing aid (No. 393).

A.C.-D.C. HEARING AID

THE hearing aid shown above will operate on 110 V., A.C. or D.C. Consists of a 2-stage amplifier using two type 37 tubes and a 25-5 rectifier, which also supplies the mike current.

Said to be hum free in operation. It is housed in a case 11 x 5½ x 7½ ins. high; weight, 5 lbs., complete.

A TALKING, "WALKING" BAR

A WIDEAWAKE manufacturer has just introduced a series of radio receivers with cabinets having compartments in the top which are elaborately fitted with glasses, measuring spoons and cups and other necessities for post-prohibition liquid nourishment.

The radio receiver is contained in the lower part of the cabinet, which is made of solid wood and is equipped with rubber-tired wheels to facilitate moving the "talking bar" from room to room. Several well known manufacturers supply the sets.



Name of manufacturer of any device will be sent on receipt of a self-addressed, stamped envelope. Kindly give (number) in description under picture.

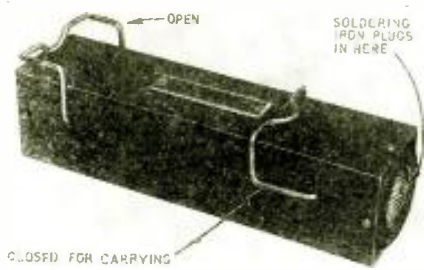

Soldering iron holder and stand (No. 395).

SOLDERING IRON HOLDER

THE unit above is a combined stand and holder for the soldering iron. It serves two purposes. First, it is a handy iron holder (supports open); and second, when ready to leave the job the iron may be inserted in the holder and the latter *at once* dropped into the tool bag (supports closed).

SERVICING HARDWARE KIT

A COMPLETE assortment of screws, nuts, washers and other essentials (see below) of the Service Man is sold by a well known radio set manufacturer.



Servicing hardware assortment (No. 396).

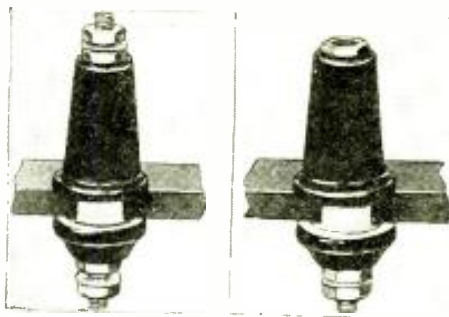

Porcelain stand-off insulators (No. 397).

STAND-OFF INSULATORS

THE experimenter will find many uses for these glazed porcelain insulators in his work. They are available in several sizes from $\frac{5}{8}$ to $1\frac{1}{4}$ ins. high and require only one hole for mounting. Larger sizes supplied with jacks for plug-in coils and all high-voltage uses.

PIEZOELECTRIC PICKUP

THE phono. pickup shown below is a high impedance, high-quality unit using a piezoelectric crystal as the transcribing mechanism.



Piezoelectric phono. pickup (No. 398).



Six V. P.A. Systems (No. 399).

6 V. MOBILE P.A. SYSTEM

THIS system consists of a P.A. amplifier, a dynamotor and filter, a 2-speed turntable, phono. pickup, two matched 12-in. dynamic reproducers and a 2-button microphone. The amplifier uses three stages supplying over 20 W. power with a gain of 79 db.; weight 65 lbs.

LOW-LOSS SOCKET

THE requirements of high-frequency have necessitated the design of special sockets such as this type with isolantite insulation and cadmium plated contacts.



A low-loss tube socket (No. 400).

ELECTRON-COUPLED SERVICE OSCILLATOR

THIS oscillator is an electron-coupled, A.F. modulated signal generator of unusual design. It operates from any 110 V. A.C. supply and covers the entire frequency band from 90 to 1,600 kc. *without resorting to harmonics*. This is accomplished by using three separate coils and calibrating the fundamental frequency of the oscillator for each coil.

The entire coil assembly is permanently mounted within the unit—the shift from one frequency range to another being accomplished by means of a double-pole 3-position switch.

Each unit is individually calibrated against crystal controlled standards; precautions have been taken in the design of the electrical circuit and in the mechanical construction to insure the highest degree of accuracy attainable without resorting to elaborate and costly crystal control and temperature controlled systems.

The circuit has been specially developed for this unit and employs true electron coupling to produce the maximum frequency stability and to prevent reaction between the output and the oscillating circuits.

A type 41 power tube is used with applied voltages well below the rated values, to insure long life and constant service.

The shielding of the entire unit is sufficiently complete so that very low output voltages can be obtained. The output is controlled by a potentiometer in the output circuit. This feature increases the usefulness of the oscillator not only because it provides a means for estimating the sensitivity of the receiver being adjusted, but also because it facilitates the adjustment of I.F. and R.F. circuits of receivers with A.V.C.

The three positions of the frequency control switch correspond to the following frequency ranges: range A—90 to 200 kc.; range B—170 to 550 kc.; and range C—500 to 1,600 kc. This wide band of frequencies makes it possible to adjust practically every type of receiver, including "long-wave" superheterodyne sets which employ intermediate frequencies as low as 95 kc.

Frequency reference points such as 90, 115, 175, 465, 550 and 1,500 are individually plotted on the calibration curves to insure the greatest possible accuracy at these commonly used points.

The entire oscillator is housed in a crystalline finished cabinet 7 x $4\frac{1}{2}$ x $2\frac{1}{2}$ ins. deep.

The circuit diagram of the unit is shown in the accompanying illustration, which illustrates how the shifting from

(Continued on page 486)

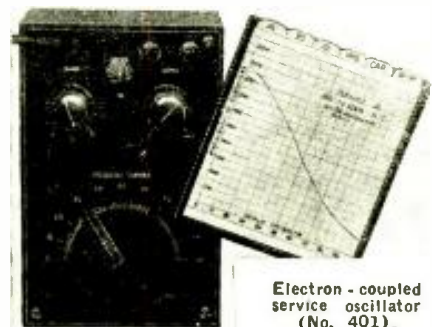

Electron-coupled service oscillator (No. 401).

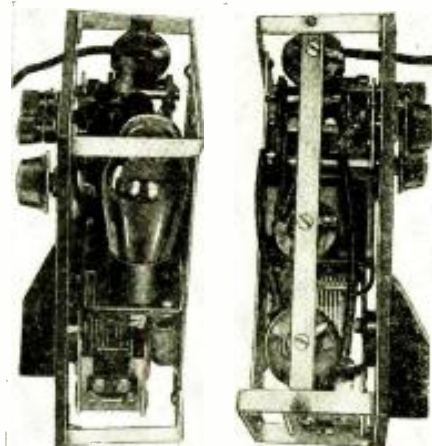

Interior views of the unit.

INTERNATIONAL RADIO REVIEW

S.T. 500 RECEIVER

IN a recent issue of POPULAR WIRELESS magazine, John Scott-Taggart, the well-known English engineer described a new receiver which has attracted a lot of attention. As shown in the circuit below, Fig. 1, the receiver uses a T.R.F. circuit with regeneration both in the detector and the R.F. stages.

It is claimed by the author that this double feed-back arrangement has many advantages over other systems. Some of these advantages are, controllable selectivity in the aerial circuit, which permits elimination of adjacent channel interference; elimination of losses in the aerial coupling circuit, due to regeneration in the R.F. stage; double regeneration supplies an amplification equal to many R.F. stages according to the claims; double class B audio amplifier supplies high output and economy in "B" current.

The detailed illustration below, Fig. 2, shows the difference in selectivity provided by different R.F. and detector circuits. It will be noticed that according to the illustration, which appeared in POPULAR WIRELESS, the S.T. 500 receiver is much more selective than the other methods shown. The phase-adjusting system of regeneration control is smooth in action and permits adjustment right up to the point of oscillation.

The values of the parts used in this set are indicated on the schematic diagram. However, no coil details were supplied in the article, as many manufacturers in England are supplying special components for this set.

It is of interest to note that this up-to-the-minute English set uses two tun-

HERE is what the radio experimenter has been wanting for a long time—a semi-technical review of the thousands of new ideas which are continually appearing in overseas publications. Each month there are received at the offices of RADIO-CRAFT hundreds of daily, weekly and monthly magazines originating from every point on the face of the globe.

SINCE the cost of subscribing to each of these would be prohibitive for most radio men, we have arranged with technical translators to prepare for our readers reviews of all the really important, new developments illustrated and described each month in these international radio periodicals.

NOTE that the only available information is that which is published; the experimenter must adapt the ideas to whatever equipment he has on hand.

ing controls—the tuning condensers are not ganged.

A NEW TUNING SYSTEM

RADIO experimenters in Europe are showing considerable interest in R.F. coils with iron cores, as we have pointed out in previous issues of RADIO-CRAFT.

In a recent issue of POPULAR RADIO,

a magazine published in Denmark, another of these iron-cored R.F. coils was mentioned. As shown in Fig. 3, it consists of a closed core, upon which the coil is wound. An air gap on one side of the coil is equipped with a wedge-shaped plug of the same material as the core.

By varying the position of the wedge, the air gap is increased or decreased, with a resulting variation in the reluctance of the core. This change in reluctance changes the inductance of the coil and thus tunes it.

A LOW-PASS FILTER

THE practice of using some sort of tone control whereby heterodyne interference may be minimized by reducing the high-frequency response of a receiver is fairly common. Unfortunately, most of the methods in use are rather crude and instead of cutting off sharply at the desired frequency, taper off gradually from a much lower frequency. This affects the quality considerably.

A recent issue of WIRELESS WORLD, an English magazine, showed a circuit for a scientifically designed low-pass filter which cuts off sharply. The circuit of this filter is shown in Fig. 4. The actual values of inductance and capacity will have to be worked out experimentally.

AN ADJUSTABLE SCRATCH FILTER

WHILE the design of phonograph pickups has advanced considerably in the past few years, and methods of making records have been revolutionized,

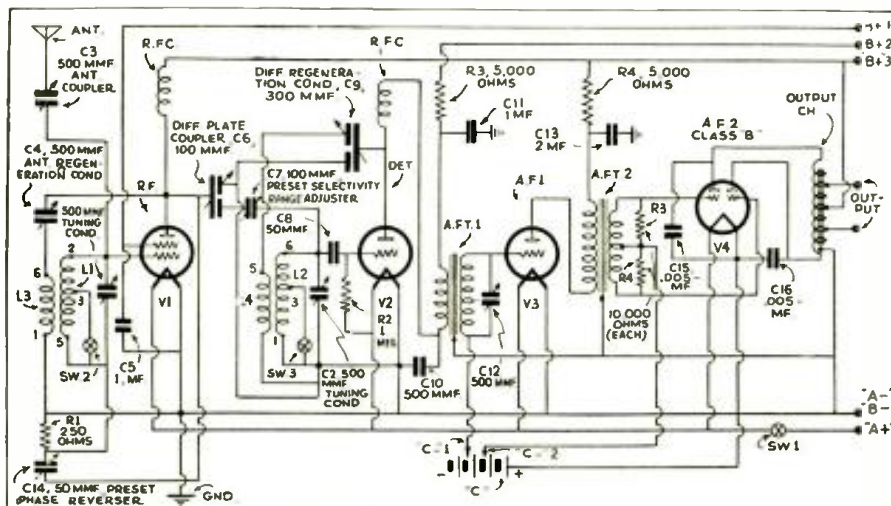

Fig. 1

The schematic circuit of the S.T. 500 which is attracting much attention in England.

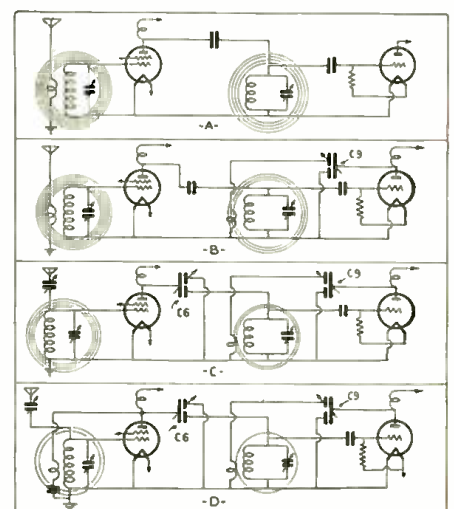

Fig. 2

The relative selectivity of the S.T. 500 (D).

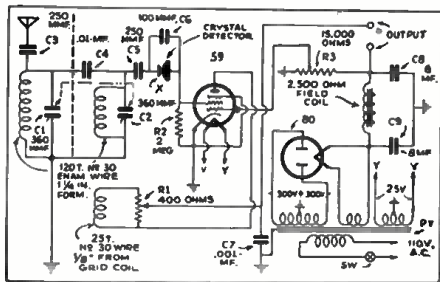

Fig. 10

The Megadyne receiver brought up to date. This circuit is a modern version of the set designed by Mr. Hugo Gernsback.

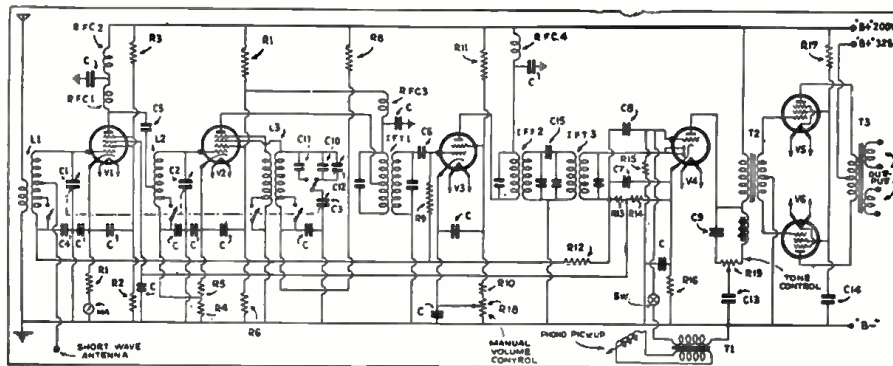

Fig. 9

A German all-wave superheterodyne receiver with some very novel characteristics.

the electrical reproduction of phonograph records is still affected by the presence of "surface noise."

In WIRELESS WORLD an article appeared, recently, describing the construction of a flexible scratch filter with adjustments both in the cut-off frequency and the sharpness with which cut-off is accomplished.

In the majority of pickups the natural resonance lies between 2,500 and 5,000 cycles and a suitable choke for this range is shown in Fig. 5A and B. The coil consists of two 3-in. discs spaced by a 3/4-in. diameter disc. It consists of 7,000 turns of No. 34 D.S.C. wire.

The values of parts are shown in Fig. 5A. The capacity, which controls the frequency of cut off, can be varied from .002 mf. to the minimum of the variable condenser. The sharpness of cut-off is controlled by potentiometer R1, R2, while the volume is controlled by the 50,000 ohm potentiometer.

in which the two coupling condensers connecting the plates and the grids of the opposite tubes are replaced by crystals. This circuit is particularly useful in multivibrators: i.e., oscillators rich in harmonics, which are often used for measuring and calibrating purposes.

INTERFERENCE LOCATOR

A RECENT issue of WIRELESS MAGAZINE contained the circuit of an interesting interference locating unit, made by Siemens and Halske, well-known European radio engineers. The circuit is shown in Fig. 7.

It consists of a 3 tube screen-grid T.R.F. set, equipped with a loop aerial and "a search antenna," which comprises a small coil connected by a shielded lead to the control-grid circuit of the R.F. amplifier. The loop is used for preliminary adjustment to find the location of the interference and the search coil is used to locate the exact source of the noise.

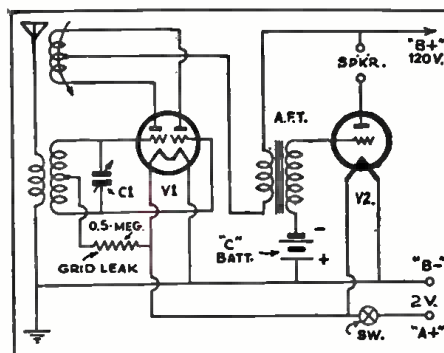

Fig. 8

The experimental class B detector circuit.

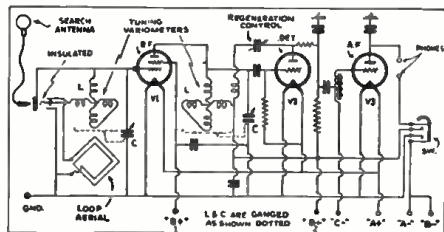

Fig. 7

An interference locator for service work.

A NEW CRYSTAL-CONTROLLED OSCILLATOR

THE illustration, Fig. 6, shows a new R.F. oscillator arrangement which avoids some of the pitfalls encountered with crystal control operation. This circuit appeared in RADIO WELT magazine.

In order to secure operation free from disturbing "side resonances," two quartz crystals having exactly the same natural frequency are required. The transmitter is wired as a balanced generator

A CLASS B DETECTOR

THE circuit in Fig. 8 shows an interesting experimental detection system which was described in AUSTRALIAN RADIO NEWS, recently.

It consists of a twin class B tube, (similar to the type 53) connected as a full-wave, grid leak type, detector. This has two distinct advantages over single tube arrangements according to the original article. The first of these is in the fact that the R.F. currents in the plate circuit of the tube are opposite in phase and balance each other

(Continued on page 495)

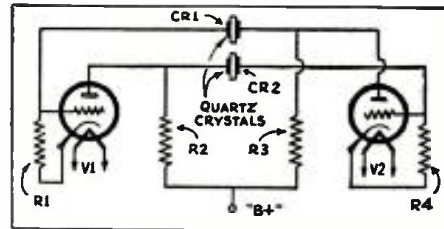

Fig. 6

The circuit of the double-crystal oscillator.

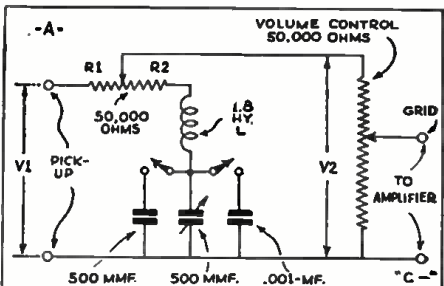

Fig. 5

A flexible scratch filter for phono quality.

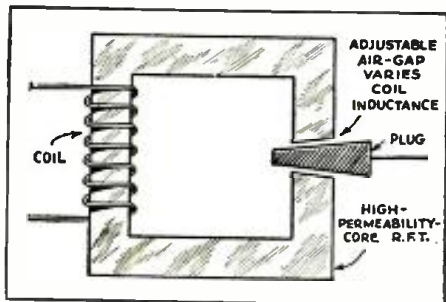
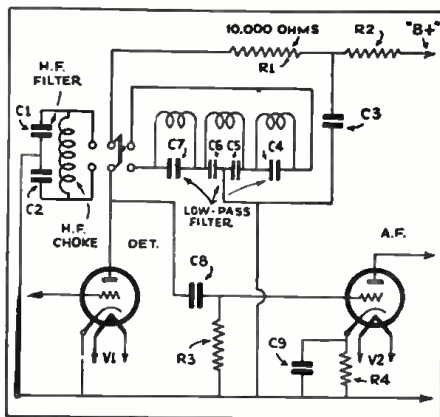

Fig. 3, above

The inductance is varied by core reluctance.

Fig. 4, right

A low-pass filter for detector bypass.





"Shooting" a remote bird to record its sounds.

At thousands of points throughout the world technicians are battling, each in his particular way, to overcome difficulties that to the lay mind appear to be insurmountable; the trained man, however, readily appreciates the feasibility of the ideas. It is in non-technical explanation of the difficulties besetting one group of inspired workers that Mr. Gene A. Day describes the technique of recording the sounds of birds. Unlike the woodsman—gun equipped, or the fisherman—with rod and reel, our "sound hunter" fares forth with equipage that must astonish the denizens of the forest—a sound truck, a parabolic reflector, a microphone, and a sound truck equipped with amplifiers and the necessary apparatus for recording sounds on film and disc.

GENE A. DAY

HOW THE SOUNDS OF BIRDS ARE RECORDED ON FILM AND DISC

RADIO, invading the virgin field of nature study, has scored another decisive triumph by facilitating the production of the first extensive series of "bird talkies" made for educational purposes.

Credit is due to Mr. A. R. Brand who has made some 30,000 ft. of bird-song talkie film. During his three seasons of recording bird notes he has obtained original records of 90 different varieties of American song birds. To increase the use of these remarkable bird sounds Mr. Brand has had phonographic records—"discs"—made from these film records which can be circulated readily and widely. Wherever phonographs are available, in even the smallest rural schools, these bird calls can be reproduced realistically, so that youngsters may learn to distinguish between them and to identify the avian singer by the varietal peculiarities of his calls or key tune.

Locating the Microphone

Mr. Brand conceals the microphone in making his bird talkies close to the known perch of a feathered songster. Dependent on the species of bird whose lilting notes are being recorded, the mike is set somewhere from 1 to 15 yards from the avian opera singer's rostrum. If the mike is too close to the songster, an irregular, discordant record results which is ruined by the blasts of sound. If the mike is in exactly the right position for that particular variety

of bird, the resultant talkie is so accurate that it will almost fool the bird's mate.

The bird talkie makers use a specially equipped sound truck, designed and built for the unique purpose which it now serves so well. The arrangement is such that the condenser microphone is attached to 250 ft. of shielded rubber covered cable which is mounted on a revolving cable attached to one of the doors of the truck. Thus, the sound truck can be stopped at a strategic point along the highway or byway and the mike extended to the song perches of the birds located in a secluded nook some distance from the road. Happily for the avian music recorders, song birds visit their customary perches for singing practice at approximately the same time daily. There are many handicaps, however, which make the task difficult as some varieties begin to sing before the first peep of dawn, even before 4 A.M. in the summer time. That means that the bird song recorders must be in the field as early as 3 A.M. during the mating season from April until August, when bird music is the best of the year.

The end of the waterproof cable that terminates at the motor truck is attached to the sound camera which is loaded with talkie film. The condenser microphone is a standard apparatus such as is used commonly in the modern talking motion-picture studio, while the sound camera and amplifiers are similar to those employed by professional talkie

producers. These instruments have been modified and adapted for the special purpose for which they are used. An interesting feature of the sound recording hook-up is a parabolic sound reflector 3 ft. in diameter, which provides a large surface for sound reception. This reinforcement results in better records than would obtain if the small receptive surface of the microphone was the only focus for bird song registration.

Making the Sound Reflector

It was only after months of experimentation that Mr. Brand and his aides succeeded in perfecting a sound reflector which would satisfy their require-

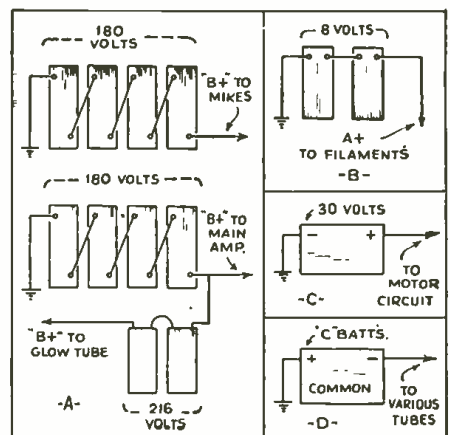

Battery connections; see block illustration.

Radio's ramifications are now so extensive as to bewilder the technician who is confronted, for the first time, with a listing of them. Thus, it is not at all unusual to find the vacuum tube—the mainstay of radio—serving manifold uses. As, for instance, in the recording of bird sounds that no other means are capable of accomplishing. Subsequent issues of RADIO - CRAFT will describe numerous other uses for electronic devices—uses that to the radio man should prove to be very profitable.



The reels of "sound film" and other recording units.

ments. The search was truly a hunt in the dark, as they had no precedents upon which to base their tests. It was a case of pick and try. By the trial and error system, an efficient reflector was eventually produced. When I asked how the reflector was made, this, in substance, was Mr. Brand's reply: "First of all, we had to make a negative cast of the portable sound reflector. That cast had to be convex, parabolic, 3 ft. in diameter with the parabola having a focus of 13 ins.

"The negative, coated with thick oil to prevent sticking, was placed with the convex side upward for the preparation of the positive cast. A ring of light pipe, 3 ft. in diameter, fitted with 2 strong metal pins extending from the circumference in opposite directions (180 degrees apart) by which the reflector is supported, was placed at the rim of the negative cast. A batter was then made of plaster of paris, thin glue and hair. The glue was thinned and mixed with the hair—the hair provided the necessary body to the batter—and finally the plaster was added. Glue dries hard but is sensitive to moisture and will shrink in drying. Because it was essential that the cast conform to the negative, no shrinkage was allowable. Plaster alone sets quickly, becomes chalky, brittle and heavy. The combination of glue and plaster facilitated the production of a thinner reflector than would be possible

if plaster alone was used. The mixture permitted the production of a sound reflector with all the advantages of one made of plaster and the added attraction of measurably reduced weight.

"After a layer of prepared batter was spread over the negative cast, strips of fine wire screening were pressed into place as reinforcement so that the batter was forced through the meshes of the wire. Then another thin coat of batter was put down, followed by a second covering of wire. A third layer of batter was applied to cover the screening and the pipe ring was then mounted, the loose ends of the wire being cut short and tucked around that metal rim. All applications of the thin batter were applied rapidly because plaster sets so quickly. When the plaster surface was finished, the reflector was clamped securely to the negative cast and allowed to set for one week. At the end of that interval, the reflector was removed, cleaned and rubbed with the finest procurable sandpaper. Then several coats of "Duco" cleaner were applied, followed by a thorough spraying with Duco paint to provide a weatherproof surface and to prevent atmospheric moisture from dissolving the reflector.

"The homemade sound reflector as completed was supported on a "U" made of 1-in. piping, a floor flange tapped and fitted to take a standard tripod screw

(Continued on page 488)



A view of the special condenser "mike."



Placing the "mike" (before camouflaging).

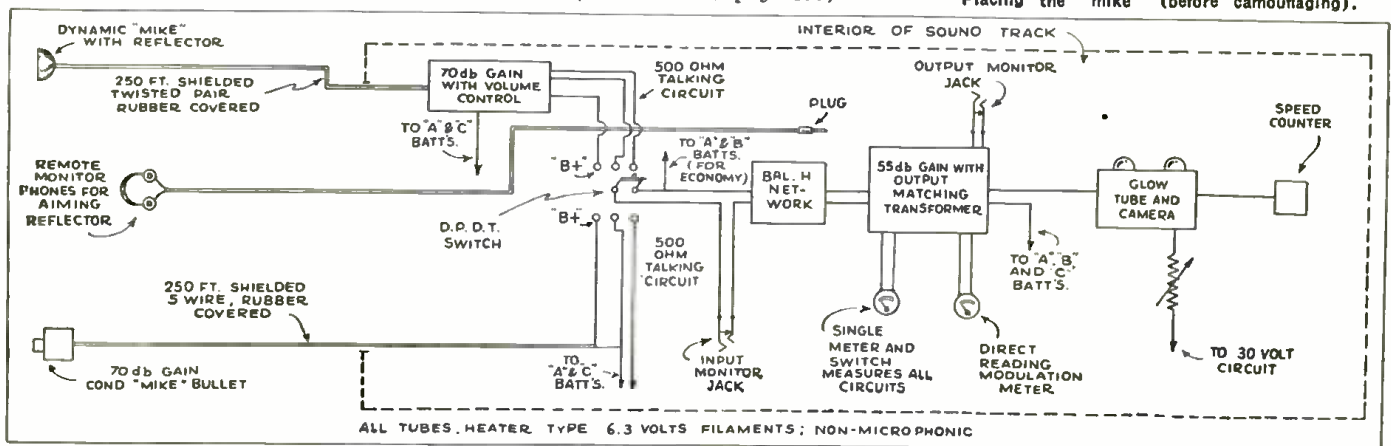



Fig. A

The endurance flight ship (left) and refueling plane (right); center, Miss Viola Gentry and, left to right, R. D. Washburne, Henry W. Roberts and N. H. Lessem.

AN AIRPLANE DUAL-RANGE RECEIVER AND 5 METER TRANSCEIVER

R. D. WASHBURNE and N. H. LESSEM

Aviatrix Viola Gentry (former non-refueling record holder), with co-pilot Frances Harrell (present women's refueling record holder) hopes to win the women's refueling endurance flight record. The authors describe the radio installation, designed by RADIO-CRAFT for this flight, for broadcast and aircraft reception, and communication with the refueling airplane and ground.

PROFITING by the experience of their previous flights, the famous endurance aviatrixes, Viola Gentry and her co-pilot, Frances Harrell, have insisted that full 50 pound allotment of radio equipment, the most they could spare, be utilized, if necessary, for entertainment and radio communication during their endurance flight. These persevering young women, sometime in December, will take off for a month's continuous sojourn in the air. They are after the women's record of 8 days in the air and then the men's record of 27 days aloft. Here's hoping they make it.

As pointed out by Jack Loesing, pilot, and Fred Fetterman, refueling operator, on the refueling airplane, the flight ship could not be shielded to prevent spark interference, due to the need for the greatest possible life from the motor. For, once aloft, it would not be possible to make any very extensive repairs; there is not even a "cat-walk" to the motor of the flight ship. The matter of shielding the refueling airplane however, is a simpler proposition and, although, at the time of making the initial tests, the operation of the radio equipment was not tested under this desirable condition, future operation may take place with the refueling airplane shielded for non-interference operation.

The radio installation called for equipment to meet two services: (1) reception of broadcast and aircraft radio programs and information; and (2) two-way communication between the flight ship and the refueling airplane, and the flight ship and ground. The former requisite was conveniently met by a new, commercially-available aircraft unit; the latter was much less easy to meet due to lack of time.

Considerable care had to be exercised both in the construction and installation of this equipment. Special precautions had to be taken to prevent the component parts from working themselves loose while operating under constant vibration. The radio communication equipment comprises two complete, 5 meter transceivers, affording two-way phone conversation between the flight and refueling airplanes, and between the flight ship and ground when the refueling ship is grounded. Every bolt and nut that went into the construction of this apparatus was permanently locked into place with lockwashers; every component part from the variable condenser down to the smallest pigtail resistor was rigidly mounted and made vibration proof. Large globules of solder were purposely formed at all electrical connection points to

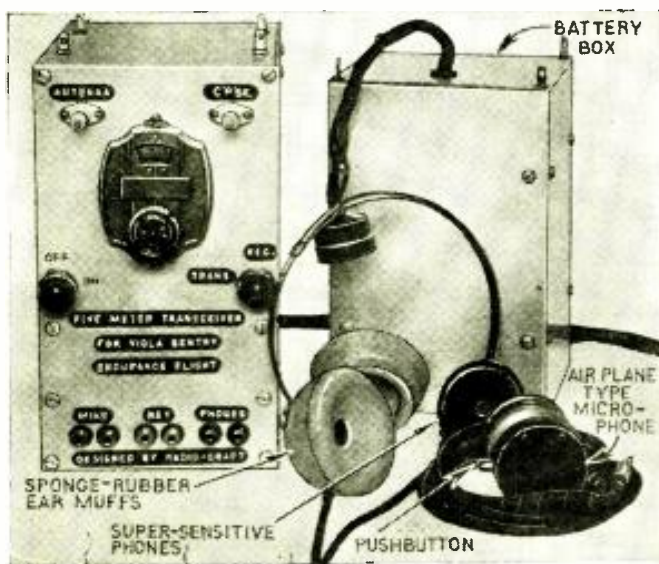

Fig. C

The complete transceiver. The button on the microphone is pressed only when talking, thus conserving microphone current. The headphones are special, "featherweight" units. As the batteries (right case) become depleted the entire case is exchanged, in the air, for a fresh one.

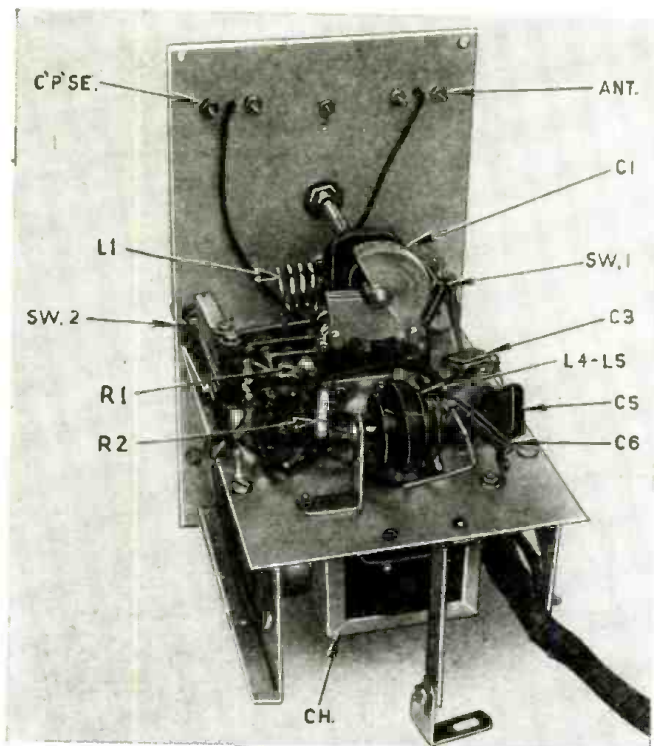

Fig. D
Top-rear view of the transceiver.

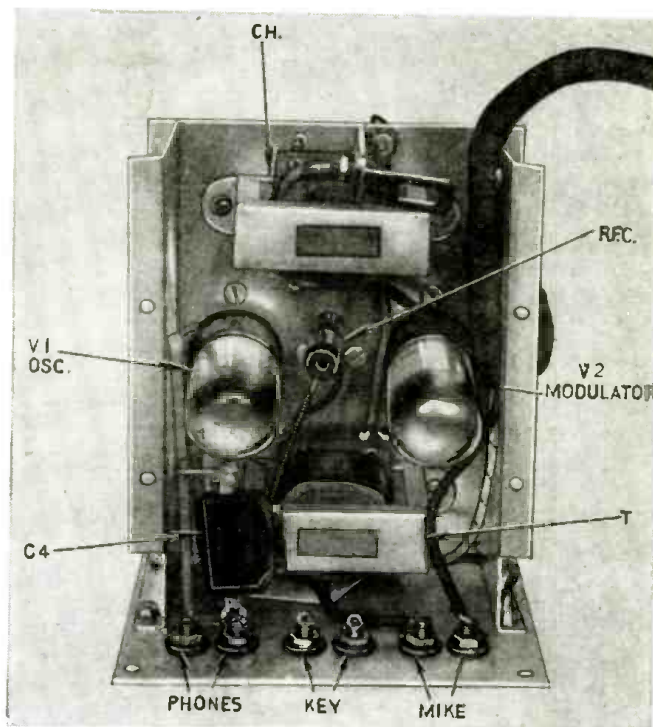

Fig. E
Underside of the transceiver, showing non-microphonic tubes.

increase mechanical rigidity. And finally, the entire transceiver was mounted in the flight airplane on two strips of live rubber, as shown in Fig. B. In the refueling ship, spring suspension from 8 different points on the transceiver was employed. To top it all, special, non-microphonic tubes, the 864's, were employed. The transceiver, complete with headphones and microphone, weighs 5½ lbs.; the power container, fully equipped, 7 lbs.

The installation of the antennas presented somewhat of a problem. The fuselages of both airplanes were constructed of duralumin, and the wings contained metal gas tanks. Since the proximity of the 5 meter antennas to all this metal would naturally result in too much absorption, the final arrangement was to stretch two quarter-wave (4 ft.) wires in a straight line, diagonally, across one side of the fuselage, using approximately 39 ins. of twisted wire for feeders to

the antenna. Best results were obtained with this current-fed type of antenna. The use of any type of raised antenna was not permitted, due to the danger of fouling the refueling hose while establishing refueling "contact" aloft.

The entertainment end of the radio equipment consisted of a dual-channel receiver known as the Crosley Air Roamio, shown in Fig. B. The receiver encompasses both the broadcast and the airplane bands; a two-way switch selects either band. A feature unique in aircraft radio operation is the complete absence of "B" batteries. Two 6 V. Hotshot batteries, arranged in series to supply 12 V., comprise the entire power supply for the Air Roamio. A particularly efficient vibrator-type "B" eliminator furnishes all plate and grid voltages for the receiver. The Roamio is designed to use

(Continued on page 497)

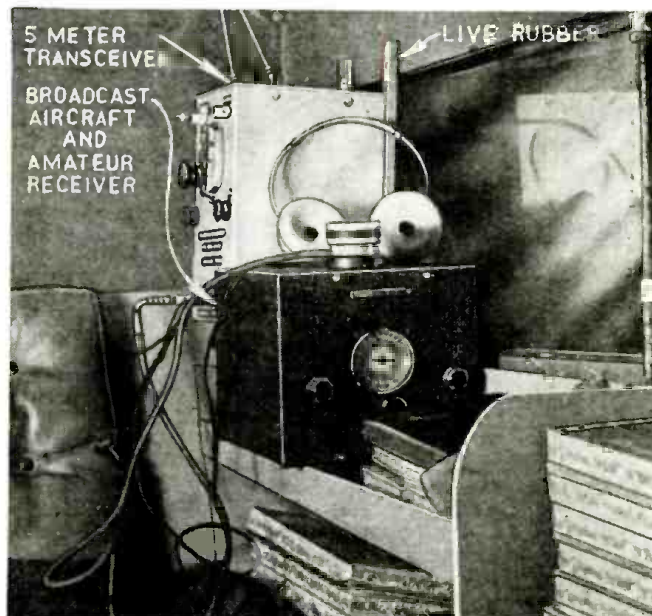
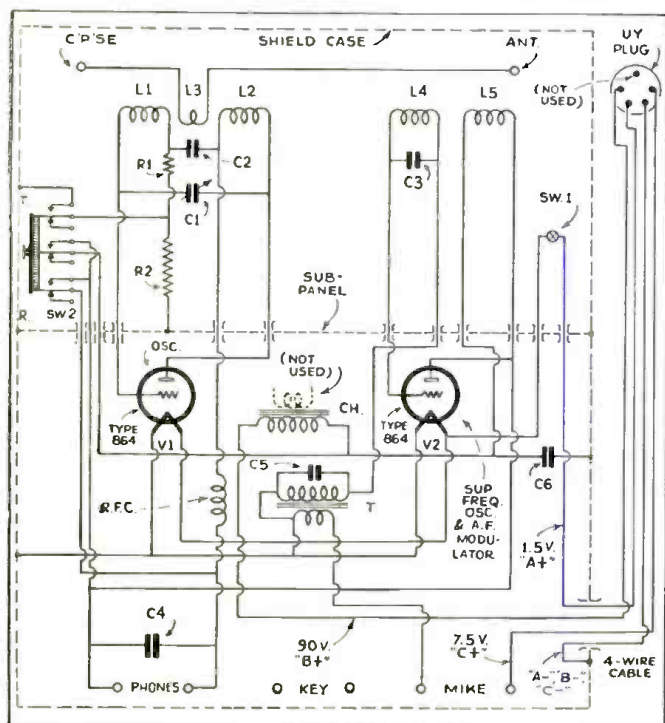

Fig. 1, left
Schematic circuit of the complete transceiver.

Fig. B, above
The radio equipment in the sleeping quarters aboard the flight ship.

HOW TO MAKE THE BEGINNER'S 1-TUBE SHORT-WAVE SET

FRANCIS R. HARRIS

Nearly every imaginable type of radio "beginner's" article, except a real beginner's short-wave set, has appeared in past issues of RADIO-CRAFT; thirteen were listed in the August, 1933 issue, page 91, and other models in subsequent issues. In his present article Mr. Harris gives complete directions for making a simple but extremely effective 1-tube short-wave set that, under good conditions, is capable of amazing results. Get a good short-wave log-book (for best listening hours, etc.), then tell us your "luck."

BROADCAST wavelengths and the programs they carry are very interesting, but the real thrill of radio lies in the short wavelengths—the higher frequencies—on which it is possible to pick up programs of all kinds from the very ends of the earth!

One or two of our previous Beginner's sets have made provision for reception of the band just below the broadcast spectrum—down to about 2,500 kc. (120 meters)—but, in general, they have been designed for broadcast reception only. This time, however, we are seriously going after the short waves and build a set that will cover everything from the broadcast down to the beginning of the ultra-short-wave spectrum. Don't get the idea, though, that this means complication and difficulty.

The set we are building this time is the simplest and the best breadboard style that we have yet constructed. It is designed for the absolute beginner who is neither radio man nor mechanic, and yet it will equal or better the performance of many more elaborate layouts.

While we are on the subject of wave bands it might be well to give a list of the principle divisions and their allotted uses; the tabulation gives the frequency in kilocycles (kc.) and the equivalent approximate wavelength in meters.

Usage	Kc.	Meters
Regular		
Broadcast	550 to 1,500	545 to 200
Short-Wave	6,000 to 6,150	50 to 48.7
Broadcast	9,500 to 9,600	31.5 to 31.2
	9,500 to 9,600	31.5 to 31.2
	11,700 to 11,900	25.6 to 25.2
	15,100 to 15,350	19.8 to 19.6
	17,750 to 17,800	16.9 to 16.8
	21,450 to 21,550	14.0 to 13.9
	25,600 to 26,600	11.7 to 11.2
Police	1,555 to 1,712	193 to 175
	2,412 to 2,508	124 to 119
Aircraft	2,300 to 3,500	130 to 85.6
Amateur	1,800 to 2,000	166 to 150
Phone	3,900 to 4,000	76.8 to 74.9
	14,150 to 14,250	21.2 to 21.1
	28,000 to 28,500	10.7 to 10.5
	56,000 to 60,000	5.3 to 4.9

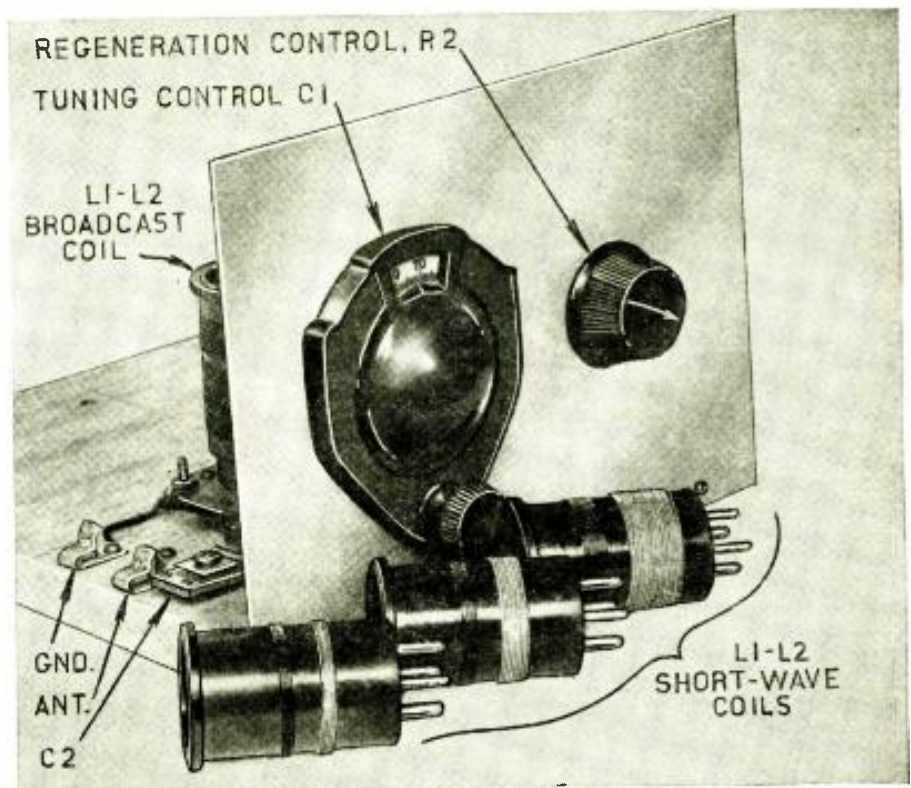

Fig. A
Front view of the beginner's 1-tube short-wave set.

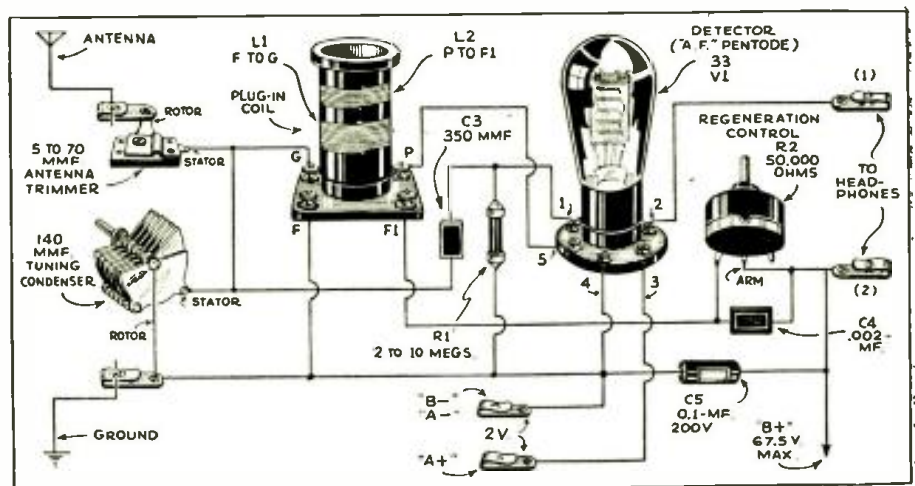

Fig. 2
Don't bother to "read a diagram"—just follow this layout.

The set we are building is designed to cover all of these bands from 550 to 18,000 kc. (545 to 16 meters), which should be ample to give a real introduction to the world of short waves; after which—unless we miss our guess—you will be, "rarin to go," to build a more elaborate layout with greater range.

Construction

The first step in construction is to get together all the material specified in the List of Parts; the necessary tools; and a fairly large, firm table upon which to work. Tool requirements are simple: a medium- and a small-size screwdriver; a pair of diagonal cutters; a pair of thin, long-nose pliers and a second pair of sturdier construction; a wood saw; a plane; a flat file and a rat-tail file; a hand-drill and a few drills (one No. 18 and one 1/4-in. will be enough to start); a soldering iron (preferably electric) and some resin core solder. Of course, you can use many more tools, if you have them, but those mentioned above will be enough to do the job.

Cut the baseboard to size (its dimensions accommodate all the batteries), clean it up with the plane and sandpaper, and give it a coat of shellac—always put a "Sunday dress" on your work; you've no idea how it adds to your reputation as a radio man among those to whom the technical details are just so many long words! (these folk usually include the treasury department—in other words, dad).

Cut the aluminum panel to size (if you didn't buy it that way) with the wood saw—it won't hurt the saw. Smooth the edges of the panel with the plane. Next, lay out and drill the three small holes along the bottom for mounting; also the two larger holes for the condenser and potentiometer. If you have a drill of the proper size for these last mentioned holes use it; otherwise, use the largest you have and enlarge the holes with the rat-tail file. Don't scratch the panel all up while working on it as that spoils the whole appearance of the set. Always put a piece of light cardboard between the panel and table top when you hold it down for drilling; and clean away all chips from underneath.

Now fasten the panel to the front of the baseboard and mount all the parts

(Continued on page 489)

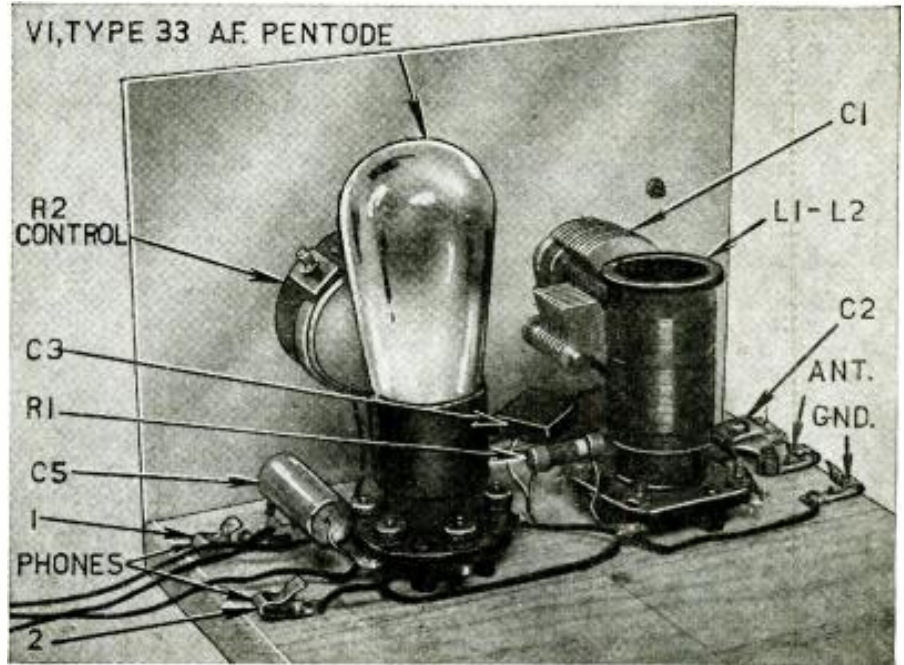

Fig. B Rear view of set, showing everything but batteries.

"BY POPULAR REQUEST"

Editor, RADIO-CRAFT:

Your new department for radio beginners is the "berries." How about a simple short-wave receiver or converter?

Jack Gray, Kingsville Golf Club, Kingsville, Ont., Canada.

Editor, RADIO-CRAFT:

Have you, or do you know of anyone who has plans for a short-wave set that a beginner could understand?

I would like to build a short-wave set that would bring in some of the S.-W. stations, yet, not to be too big a "job" for one who is just starting in the game. E. F. Schrafft, Main St., Middletown, Conn.

The letters printed above are merely two of a large number of similar inquiries for complete construction data regarding a simple and inexpensive short-wave receiver design. The instrument described by the author admirably meets these requirements. Just one vacuum tube, and a few miscellaneous parts and, presto, you have a set that is capable of receiving radio programs originating thousands of miles away.

If your knowledge of radio does not extend to a working acquaintance with schematic circuits, just follow the picture diagram in building up the set.

What other instrument designs would you, as a beginner, like to see in RADIO-CRAFT?

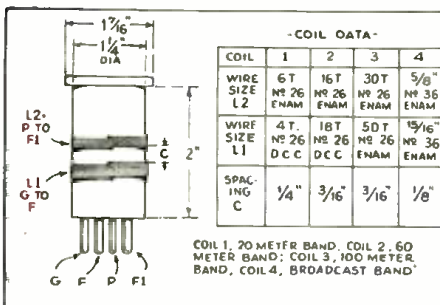

Fig. 3

Complete coil-winding data.

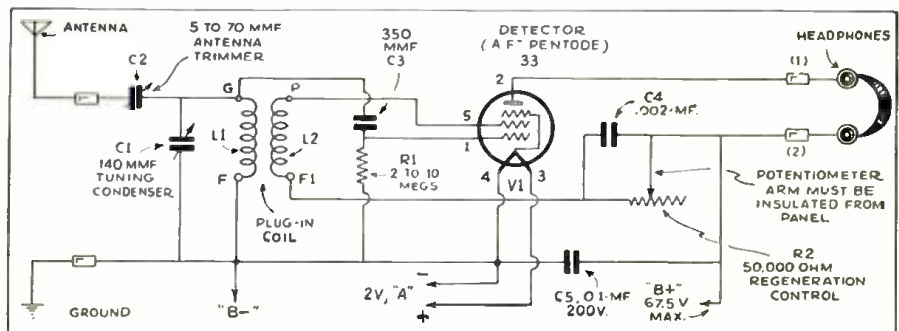

Fig. 1 The diagram—for those who insist upon schematic circuits.

SHORT-CUTS IN RADIO

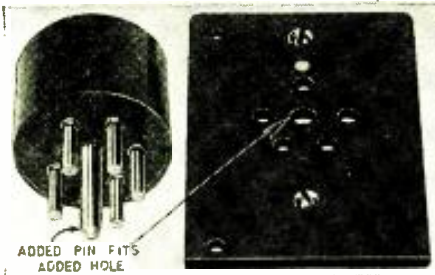

Fig. A
The added pin facilitates tube insertion.

A TUBE SOCKET IMPROVEMENT

E. J. Koshollek

IN the illustration above (Fig. A) is shown a kink for simplifying the insertion of tubes in their sockets. You will note that the tube base has a centrally located pin to act as a guide in centering the tube over the center of the socket. The pilot pin, being longer than the active tube pins, acts as a pivot allowing the tube to be rotated until the active pins are aligned with their respective socket holes. An editorial in the November, 1932 issue of RADIO-CRAFT gave added incentive to this idea which has rattled around in my head for some time.

SECURING THE DIAL SHAFT

Thurman R. Bailey

I HAVE seen several means and ideas for holding dial shafts when putting on drum cables.

The most handy way that I have used is to get a spring from a medium-size battery clip, a washer and the knob from the radio set. Put the washer (with a 1/4-in. hole) on the shaft first, then the spring, after this the knob from the set, as shown in Fig. 1. When putting on the knob press it tightly against the spring to compress the latter; then tighten the set-screw in the knob. This will hold the shaft from turning and yet if you desire to turn the shaft you can do so.

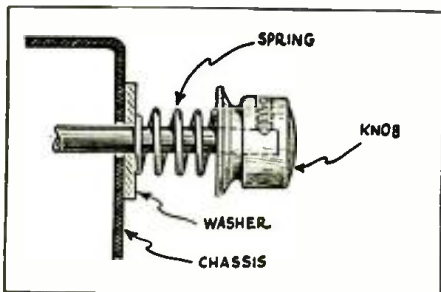

Fig. 1
Securing the dial shaft for alignment.

TESTING PENTODES

E. J. Brockway

ON this page are shown the necessary changes for adapting the Jewell 409 tester (serial 2291—all black buttons) and the Supreme model 50 tester for testing pentode tubes.

In the case of the Jewell instrument, a push-button switch with six contacts is mounted 1 in. below the 16 V. A.C. filament push-button. The 800 V. resistor spool for the D.C. plate voltmeter is also removed. The other changes in the wiring are determined by reference to Fig. 2A.

The changes for the Supreme model 50 unit are shown in Fig. 2B. A jack is mounted next to the 5-prong socket on the right side of the panel. This is equipped with a bakelite plunger, for changing the circuit to test the pentode tubes. A good 47 tube will read 57 to 61 ma. with the plunger in the jack.

RENOVATING OLD SUPERHETS.

P. C. McDaniel

HAVING serviced many superheterodynes, I've found that some are very sluggish or dead on distance. No amount of adjustment of the trimmer condensers will hold the modulator and oscillator circuits in exact step over the frequency band, due to the fact that the capacity in the variable gang sections will not hold in exact step for every setting on the dial. Therefore, many D.X. stations are hopelessly lost.

Hints, "kinks," ideas and suggestions that enable the amateur and professional to save time and money.

Paralleling or shunting both the R.F. and detector circuit condensers with a very small variable capacity (not to exceed 8 mmf.), and brought out as a control on the panel will permit a micrometer adjustment of these circuits, and will cause the old super. to take on new life.

Procure two very small midget condensers of the 3 plate type, which usually range from 3 mmf. to 15 mmf., very carefully remove rotor sections and drill or cut out as per Fig. 3B. Use extreme care so as to not warp or bend the plates.

Solder a very small machine screw, 6-32 or 8-32 thread, to each end of stator plates or sections. These two stator sections being held together by narrow strips of bakelite fastened across the ends (Fig. 3B). Use great care to keep

(Continued on page 506)

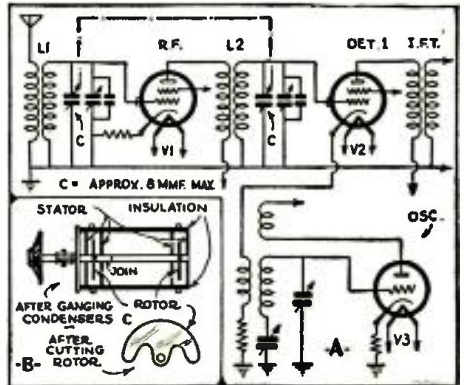

Fig. 3

This trimmer arrangement aids D.X. reception.

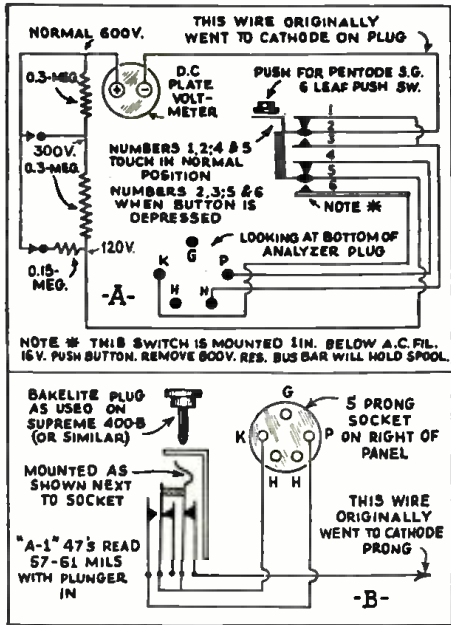

Fig. 2

Testing pentodes in two popular set analyzers.

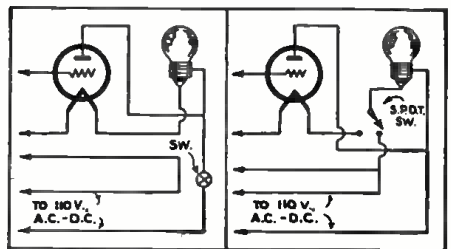

Fig. 4

The single-pole double-throw switch on the right permits the lamp to be used alone.

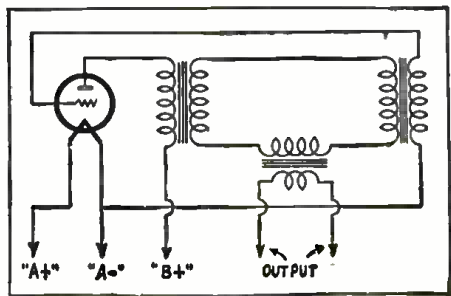

Fig. 5

An oscillator that produces fine waveforms.

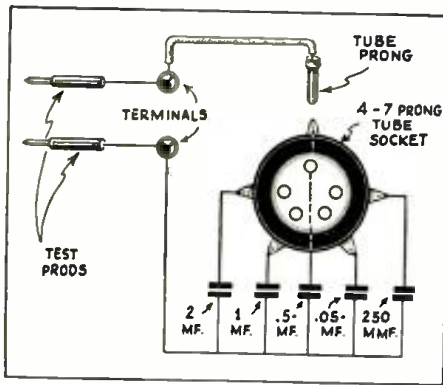

Fig. 6

This switch, which has many possible applications in radio reception, is limited in contacts only by the type of socket used.

AN EASILY-MADE SELECTOR SWITCH

Charles T. Machin

HERE is a handy multi-point switch that I have found very useful for numerous applications, the number of switching points available depending on the type of tube socket used.

Figure 6 illustrates one of the applications possible with this switch, a little device that I have found useful for checking open condensers and condensers of insufficient capacity, in testing radio receivers.

IMPROVED TRANSFORMER WINDINGS

Charles H. Dammers

THIS radio kink has been very helpful in winding transformers.

When winding power transformers and one wishes to obtain maximum efficiency in a cramped space, especially in midget transformers, I discovered the following method for putting on more turns than ordinarily possible.

Instead of using end plates on the coil form, make the insulating paper between layers much too large. Then cut the ends so as to leave a flap to be folded over the windings near the ends of the coil. (See Fig. 7.) This will permit you to wind clear to the end without danger of the windings coming undone. After the flap is folded over, the next layer is wound over it and keeps it firmly in place.

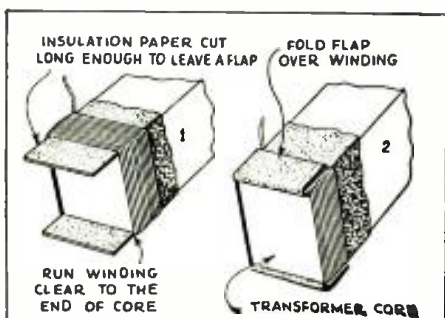

Fig. 7

Midget transformers can be made by this method.

A NEON-TUBE CONDENSER TESTER

J. R. Higginbotham

HERE is a wrinkle I have never seen published. Most Service Men and experimenters are interested in ways to test condensers, so here is a tester that does not cost much to build and takes up very little space. (Fig. 8).

It operates directly from the A.C. line in conjunction with a 25 W. lamp and an ordinary triode, such as the 01A. A little experience in testing condensers of different sizes will soon show the difference in operation between a good one and a poor one.

A SIMPLE CONTINUITY TESTER

W. E. Chorpenning

THE illustration, Fig. 9, is almost self-explanatory. Two discarded Philco-tron electrolytic rectifiers are "resurrected," cleaned and refilled with liquid from other discarded members of their tribe. In constructing my own, I bored holes in a shelf just the size to allow the jars to be slipped up through as far as the square part. A tin clamp run under both jars and tacked to the shelf at each end kept them rigid. The 2 mf. condenser was also held in place by this clamp. The only purpose of the condenser is to boost the voltage. Without it the rectified voltage is only 30 to 50 V., while with it in the circuit, the voltage is increased to about 100 V.

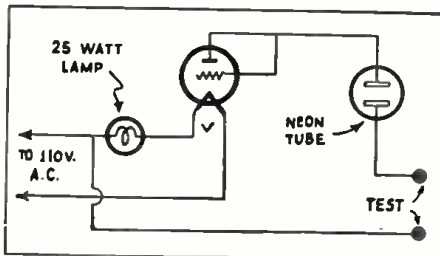

Fig. 8

This hint will test condenser quality.

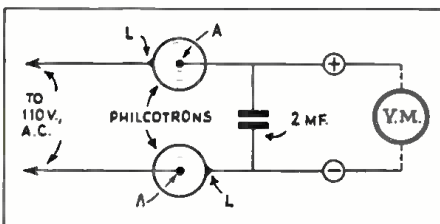

Fig. 9

A continuity tester made from old parts.

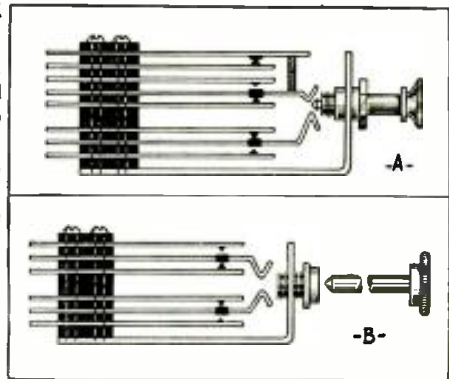

Fig. 10

Two types of jack-switches for analyzers.

The idea that will appeal to most is that this tester may be assembled without cost and will be as good as some very expensive ones. I am presuming, of course, that a good voltmeter is already in use about the shop.

AN ANALYZER JACK-SWITCH

Haven Thompson

IN CONSTRUCTING an analyzer, and wishing to keep the cost as low as possible without detracting from the appearance or efficiency of the instrument, I hit upon the idea of using Freed-Eismann 8 blade snap switches (Part No. 2017) instead of the push-button type. With a few simple changes shown in Fig. 10, they answered the purpose nicely, and also reduced the cost considerably.

The switches were converted into jack-switches and a short piece of 1/4-in. hard-rubber rod, screwed to a binding-post head, was used as a jack plunger, similar to the method used in the older types of Diagonometer.

To convert the switch into a jack, remove the brass plunger by unscrewing the bakelite tip. Then remove the two top blades by unscrewing the bolts that hold them to the frame. When assembling, make sure that the small tubing, which insulates the blades is cut off slightly shorter than the remaining blades and spacers. In the end of the 1/4-in. hard-rubber rod, 1 1/4 in. long, drill a hole slightly longer than the threaded portion of a bindingpost and screw the two together.

(Continued on page 495)

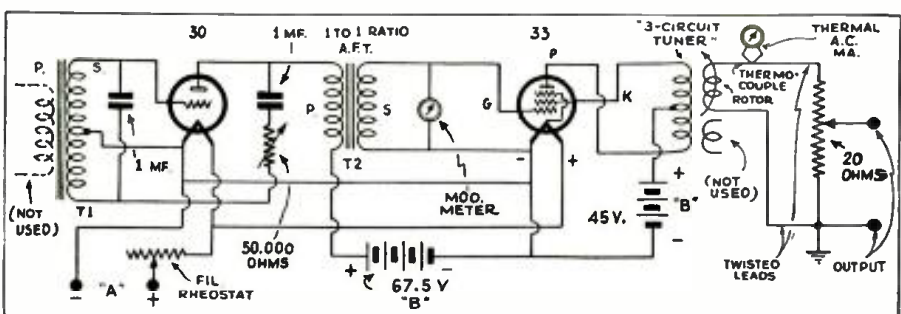

Fig. 11

The circuit above covers a "standard signal generator" for the laboratory worker.

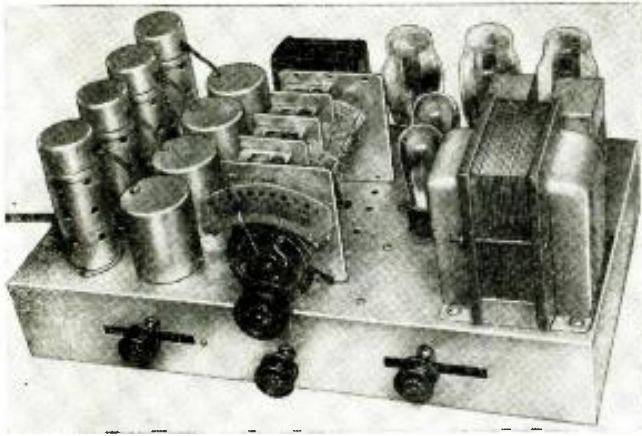

Fig. A
Front view of Mr. Block's custom-built set.

OSCAR BLOCK*

MAKING A 9-TUBE HOME-BUILT A.C., T.R.F. SET

Fidelity is becoming the foremost factor in radio set design. In this article the author describes an instrument in which tone quality was the first consideration; the detector, A.F. and power supply circuits introduce new ideas. The completed receiver was checked for tone quality by means of a peak voltmeter and frequency records. If you're a "bug" on tone, build this set.

THE RECEIVER to be described in this article is one of a series designed by the writer for the needs of a high-standard custom trade. It represents the latest evolution of a definite type of receiver adhered to for the last two years, whose changes have been the result of much experimental work and a constant endeavor towards improvement.

This latest set has the following features; some usual, others unusual and which will be set down in numerical order for discussion later:

(1) A high-gain 3 stage T.R.F. amplifier using type 58 tubes in a circuit arrangement essentially stable and easily controllable even at maximum operating conditions.

(2) An unconventional detector output system featuring both resistance-capacity output and direct coupling.

(3) A push-pull first A.F. voltage-amplifier stage that is a composite between a single tube and true push-pull operation. Unlike previous phase-shifting or phase-splitting input circuits this circuit is designed not for greater power output but for greater input handling ability. Its operation is automatically dependent upon signal frequencies and its compensation is automatic on those frequencies where overload normally occurs in an A.F. first stage operating at large detector outputs.

(4) A composite class A and class B power output stage using type 2A3 tubes operated so that they are capable of their full rated outputs (unusual in most sets using 2A3 tubes). With its potential power reserve this stage supplies a bass response singularly lacking in the tremolo so undesirably present in many sets (which lack the ability to bring out signals at less than maximum output).

(5) A socket power filter unit, whose voltage regulation between maximum and minimum output potentials is around 5% as contrasted to the usual value of 15 to 25% found in multi-tube receivers. The rectifier used is a type 5Z3.

Referring to the circuit diagram, Fig. 1, in the order in which they were listed, the above points are explained.

I—Maximum possible R.F. gain is achieved by operating the type 58 tubes at the full recommended plate voltage of 250 (at the tube terminals) and 110 V. on the screen-grid. The minimum control-grid bias for tubes V 1 and V 2 is set as near as possible with the slider on R 24 towards the resistor's ground terminal. The point chosen, depends on the individual set builder's discretion, as to how near to actual oscil-

WATCH FOR THIS BATTERY SET

We are going to present to the readers of RADIO-CRAFT complete construction details for building a simple and efficient battery-type broadcast receiver. This article is in answer to numerous requests for a set of just this type, for the farmer, experimenter and, in fact, anyone who for one reason or another finds it more convenient to use "door-bell batteries" than a lighting circuit, to operate the radio set.

lation he wishes his receiver circuit to come, in operation. In the receiver described, while it is possible to operate with a minimum bias on the control-grid of $3\frac{1}{4}$ V. without oscillation, the point actually used is one that gives $5\frac{1}{2}$ V. between the maximum volume position of R5 and ground. Incidentally, it will be observed that "ground" is not the "B minus" of the set. With respect to the "B minus" terminal of the supply, ground is actually 50 V. positive. This figure is arrived at by adjusting the slider on R24 furthest from the ground, so that a voltmeter between "B minus" and ground will indicate 50 V. This adjustment is made with the volume control set for maximum and the minimum bias chosen applied to the control-grids of tubes V1 and V2. With this adjustment correctly made, tube V3 will have a control-grid bias of $7\frac{1}{2}$

V. negative. This high negative bias is not used as an oscillation control of the third R.F. stage, but rather as an adjustment to decrease the sensitivity of the set. It is a deliberately inserted loss to provide: (1) less sensitivity and thus lower the noise level; and (2) protection against R.F. overloads at high volume inputs. This is desirable, since quality does not demand so much a minimum bias in excess of signal input, but a low signal in comparison to a tube's handling ability. The bias on the control-grid of tube V3 is adjustable at will, by varying resistance R4 directly with the voltage variation desired. To increase the value of R21 will increase the bias; to decrease R21 will lower it.

The coils used are the high-gain type, available from most dealers and already mounted in individual shields. Whatever coils are used *must match the variable condensers* that are to be used. For the home constructor specifications are supplied in Fig. 2. Not the least reason for the freedom from oscillation spillover tendencies is the use of complete and individual circuit-isolating resistance-capacity filters. The control-grid leads too, where exposed, are shielded. A word of caution with regard to the shielding of these leads is in order. Any insulation leakage will reduce the efficiency of the set very much; therefore, before connecting the coil grid-return leads, this point should be checked between ground and control-grid. Also to be watched is that the shielded leads are all of the same length, and no longer than absolutely necessary in order that detuning and mistracking do not occur.

II and III—The detector presents a circuit absolutely unconventional, novel and responsible for the marvelous tone and freedom from A.F. overload of this receiver. In the

* Albee Radio Service.

predecessors of this set, in the same series, the use of parallel type 47 output tubes or a type 27 followed by push-pull 45's resulted in no severe demands on the detector. However, using the 2A3's an entirely new set of conditions arose. Among other difficulties were these: Direct feeding of the output stage was impossible because it was clear that a 57 could not efficiently be used to swing 120 V. in the control-grid circuits of the 2A3's (grid-to-grid). To attempt to do so would result in the detector plate current rising to inordinate values on strong signals and varying the self-bias through such a range as to result in a distorted harmonic content in the detector output. Theoretically to follow the 57 with a 56 and then the output stage would have been sufficient to adequately drive the latter. However, with the 2A3's shifting from class A to class B operation, at about the point where the output is 6 W. good practice would demand a driver stage capable of considerable power output on its own accord, since class B operation by virtue of a grid-current draw imposes just such a demand on the preceding stage and thus push-pull operation of the driver is essential. The considerations that lead to the use of a form of push-pull in the first A.F. stage were three: (1) few class A "heater" power tubes were available; (2) power tubes drew heavy current from the power supply unit; (3) equipment for type 56 interstage operation was cheaper and more compact than that needed for operation with a power tube in the first stage.

Tests made with a peak voltmeter and frequency records indicated that all the overloading was in the bass frequencies. They also showed that good first-stage output, free from harmonics, could be obtained at maximum volume, provided operation be confined above 200 cycles and that crescendos containing heavy bass volumes below this frequency be handled only in a push-pull input circuit. The circuit evolved for the detector output and first A.F. input, had just this in mind. This is a composite between a straight resistance-capacity input and a direct cathode-grid coupling. Its characteristics may be predetermined for frequency acceptance and unlike bass boosting schemes, which function to overcome coupling and transmission losses, it functions mainly to correct for volume distortion. A study of Fig. 1 will reveal the operation of this circuit. In the detector, A.F. demodulated currents are present between the plate and cathode of the tube. By virtue of the plate-to-cathode resistance, these are of instantaneous opposite potentials. For the normal purposes of push-pull operation it would be essential to split this voltage and apply an equal potential of opposite phase to the grids of succeeding tubes. However, since our only object is to split the phase of the bass at this point and since less than a complete phase split will do, it is possible to couple the detector to the following stage with an unequal voltage applied to the corresponding input terminals and

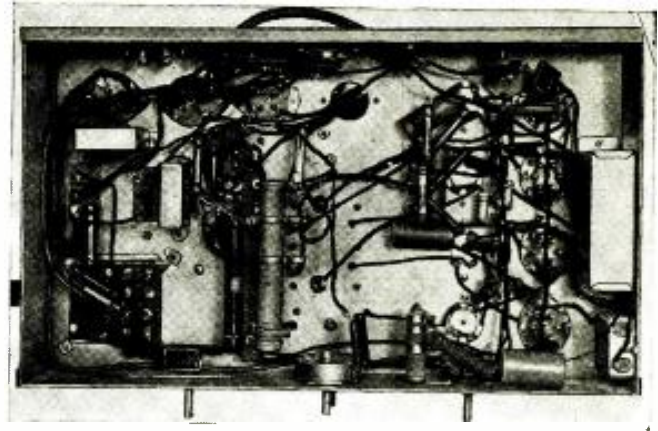

Fig. B
Underside view of the high-fidelity receiver.

yet to gain in input handling ability directly as we gain in the additional coupling supplied between the detector, V4, and the first A.F., V6. This co-efficient of coupling is mainly determined by condenser C11 which in this circuit has three functions: to serve as the degenerative condenser for the A.F. voltages which would seriously be interfered with in passing through R12; to serve as an R.F. bypass for the completion of the control-grid cathode input circuit; and to determine the voltage impressed on V6. This voltage is a function of the A.F. voltage drop across R6, by virtue of the fact that the lower the frequency, the greater the A.F. voltage across R6, since the reactance of C11 rises inversely with frequency; and the fact that as the C7 reactance rises, the voltages impressed on V6 and V5 increase and decrease respectively pulling more and more into equality as the frequency decreases. For all-round operation a value of 0.2-mf. for C11 gives (with the other values specified) the best results, a high condenser value rendering the tone extremely "boomy" and a lower value decreasing the R.F. gain without unduly increasing the A.F. gain in a commensurate degree.

The custom set builder may find it to advantage to try several condensers at C11, as the power factor of this capacity unit affects the frequency characteristic of the entire amplifier. Also, it may be to advantage to try different capacities at this point to produce the best quality.

Two other points readily observed are that the detector control-grid returns to ground, whereas the cathode returns to the "B minus" which with a zero current through the

(Continued on page 498)

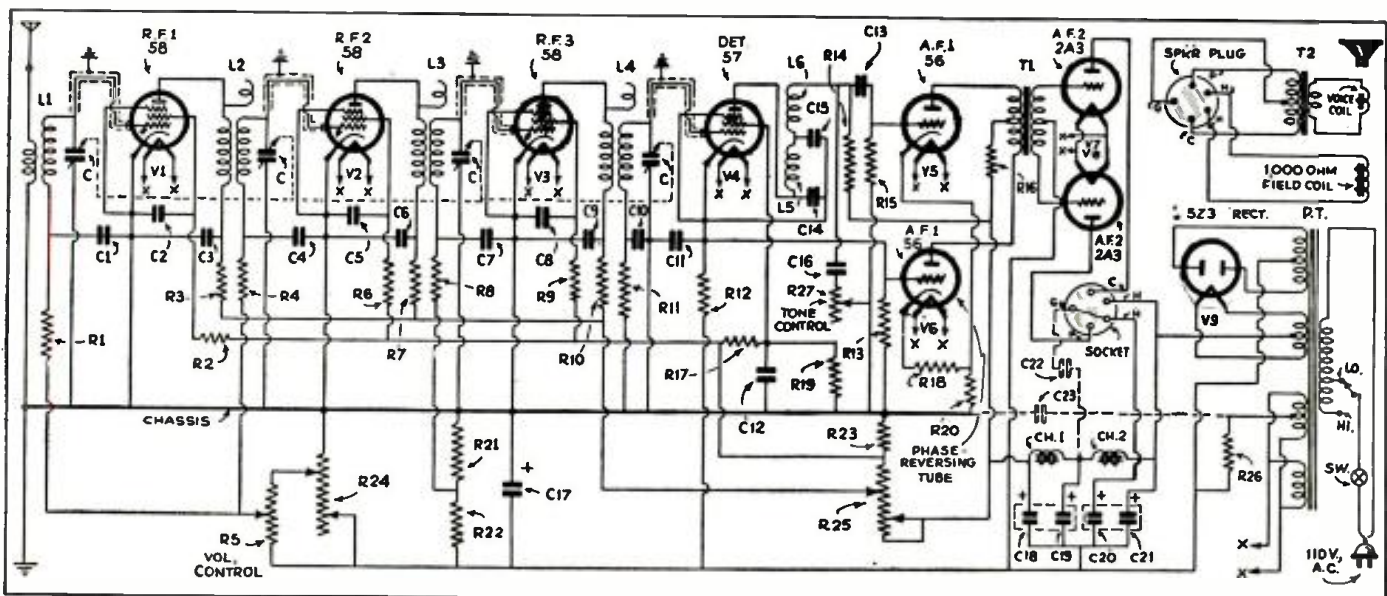
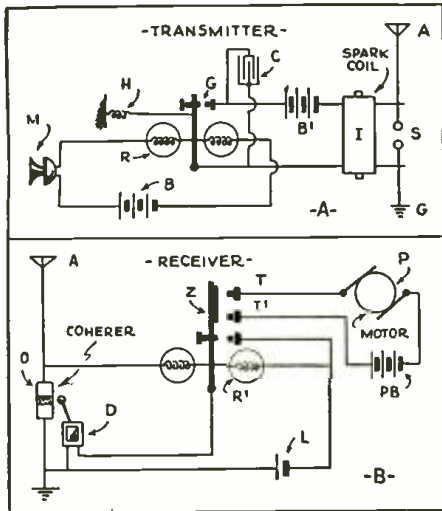

Fig. 1

Schematic circuit of the 9 tube T.R.F. set designed for exceptionally good tone quality. The A.F. and power circuits are especially interesting.



The Dynamophone radiodynamic control.

The subject of Radiodynamics, or the remote control of mechanical and electrical devices by radio is far from being new. In fact, it is almost as old as radio itself; and of especial interest is the design of voice-operated systems. As far back as 1908, Mr. Hugo Gernsback described some original experiments on this subject in his first magazine, "Modern Electrics," from which we quote as follows: "The voice has never been used, no case being on record that a motor or a dynamo was started solely by talking, to or through a medium." At the left is shown the circuit of this first radiodynamic unit—the "Dynamophone." While the apparatus is obsolete, the method of operation of this first voice-actuated device is of interest.

Experimenters find in this subject almost unlimited interest. The easily built unit described by Mr. Benson we hope will start many "budding" experimenters on the right track; further articles in RADIO-CRAFT will describe more comprehensive systems.

THOMAS W. BENSON

AN INTRODUCTION TO RADIO DYNAMICS

ALTHOUGH the term robot has been applied to all mechanisms which replace the human control element, our interest at the moment lies only in those interesting electrical devices that perform certain functions in response to the human voice, tuned sounds or whistles. As a rule such devices are rather intricate and their mode of operation a profound mystery to the majority of the beholders. It is natural that such sound controlled apparatus should create much interest and the device to be described will enable one to control electrical apparatus with the spoken word.

Many circuits have been evolved for the above purpose, most of which are actuated by the number of syllables in the verbal statement actuating the device.

The writer constructed the electronic device illustrated in Fig. A for the purpose of controlling toy electric trains and was surprised to find it stood up well, despite the abuse two boys naturally give such apparatus. The cost was also low both for material and operation and to say the least, the effort in building the device was well rewarded. There are still a few people who believe the control is accomplished by some secret button and not by words spoken into a telephone transmitter that starts and stops an electric train.

The cost of construction is low, because old radio parts are utilized and scrap-box material is used liberally. In Fig. A is shown the top view or layout of the various instruments. As a

(Continued on page 492)

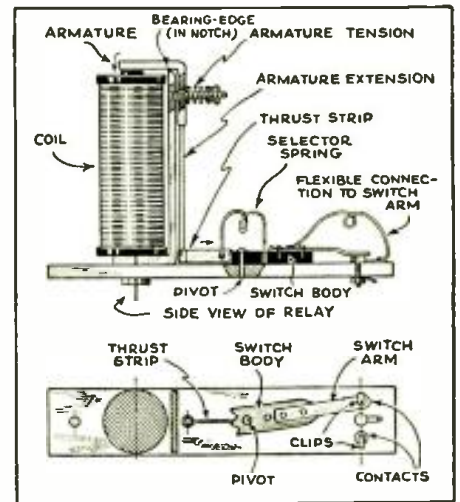

Fig. 2
Details of on-off relay mechanism.

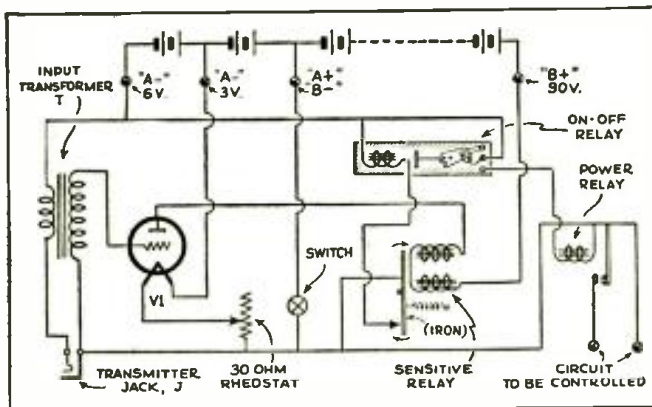

Fig. 1
Schematic circuit of the voice-operated control.

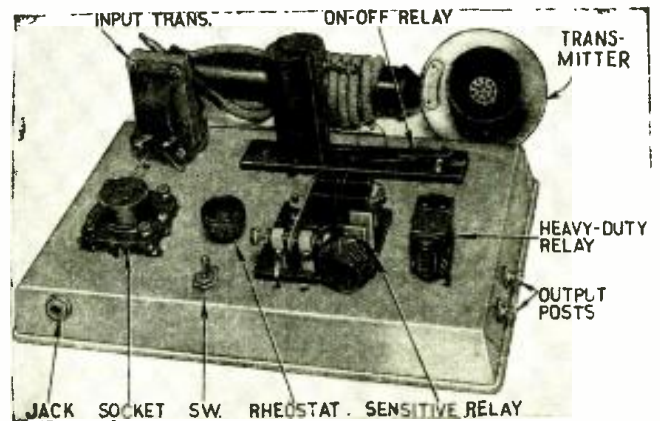

Fig. A
View of the control mounted on a cake tin.

READER'S DEPARTMENT

A department in which the reader may exchange thoughts and ideas with other readers.

RESISTANCE-CAPACITY TESTER IMPROVED

Editor, RADIO-CRAFT:

I am sending you a schematic diagram (Fig. 1) of a new (or improved) resistor and condenser test box which I recently designed and use in my laboratory with great success.

A careful study of the schematic will clearly disclose the fact that this is a big improvement over the test box described on page 266 of the November 1933 issue of RADIO-CRAFT, in that my arrangement provides for condenser test as well as for resistor test by the substitution method, all in one box and using one multipolar switch. A switch consisting of as many poles as desired may be used by one who wishes to build his own test box, and as many groups of resistors or condensers may be used as desired.

Two leads are used in connection with the pin jacks shown on the test-box panel. One of the leads is plugged in the selector jack marked S and should remain there while the other lead can be plugged into any one of the other jacks, depending on whatever you are to use (resistors or condensers) and with reference to the charts whatever group of resistor or condenser values you desire to test.

The constructor may use values of resistors to suit his case as well as a condenser chart made up as shown in Fig. 1, and these charts pasted on the test box where they can be easily seen.

Between the selector slider of the switch and pin jack, I have a 25 W., 1000 ohm variable resistor to compensate for any values of resistance desired between those in the test box or on the chart. A dial is used with this compensating variable resistor and is clearly shown on the panel of the test box in the drawing.

SAMUEL LEBLANC,
LeBlanc's Radio Laboratory,
White Castle, La.

RADIO SERVICE—PLUS

Editor, RADIO-CRAFT:

At a recent gathering of Service Men, I heard a controversy, which to me, seems a worth while topic for an article or series of articles.

I know that articles, which consist of kinks, freak troubles, operating notes, etc., while they are to me as a Service Man the most interesting of all articles, nevertheless, have no real practical value, unless I clip and file each item for reference.

The article I have in mind, has to do only with those troubles, which invariably or almost invariably, occur in specific models.

This scene took place recently. A, an experienced Service Man in whose shop the discussion took place, had just completed replacing a power transformer in a Colonial 33 and had just finished a final test before returning the set to the customer.

"Well, I'm glad that's over," said A. "Over," piped up B. "You haven't started yet.

"Aren't you going to replace the voltage divider, the detector, and first A.F. plate resistors, the detector screen-grid resistor, and the 420 ohm resistor in the negative lead of the power supply? Aren't you going to drill a hole in the chassis and put in a stop bolt so the volume-control band won't unwind, when the customer keeps turning the volume

control in the off direction, even after the arm has shut off the switch?

"Aren't you going to put a knot in the volume-control cable to take up the slack, which has developed since the set was sold?

"Aren't you going to remove the gang-condenser shield and get at the R.F. coupling condensers and shake them to see whether or not the internal connections are loose?

"Aren't you going to—"

"Hey, hold on!" cried A. "Why should I do all that, the set's perking away fine. The customer will be tickled pink when I return it."

"Yes," said B, "but for how long? You know that all these troubles I have mentioned are not only common to this model, but are almost inevitable, and I'll bet that inside of a month, you will be called back."

"O.K.," said A, "that means another service call and another couple of bucks'."

"No!" chimed in C, "that probably means another service call for *some other* Service Man, and the spreading around town that you're the bunk. And even if he does call you back, he will want the repeat call done free."

"Well," replied A, "how can I do all this, when I've already made the customer a rock bottom price. You know how you have to shave prices nowadays to get the work."

"It's your own fault," said B, "you should have taken all this into consideration when you made the price, and pointed them out to the customer. And in your present predicament, I would not tell the customer about these small replacements. After all, you can pick up good replacements for all these parts for only about a dollar, and it would not take long to put them in.

"Hereafter, I suggest that you not only repair the parts that have caused your service to be called, but those parts (and there are one or more in almost every model of every manufacturer) which are sure to become trouble-makers.

"In that way you get a reputation for being a good repair man, because the lay-man judges you not by the quality of your work, but by the frequency he has to call on you for service."

(Continued on page 490)

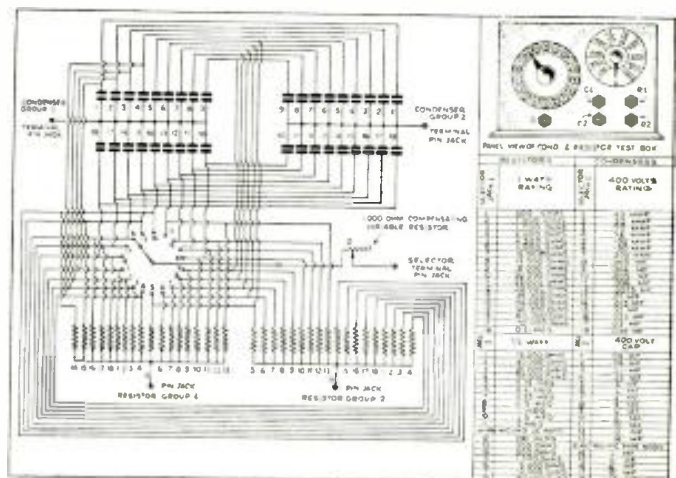

Fig. 1

This condenser and resistor tester is handy for servicing.

HOW TO MAKE A HOME-RECORDING CONTROL UNIT

The author of this article has taken into consideration a point overlooked by previous designers of home recording equipment; that is, the fact that many constructors will wish to include the control panel in the cabinet of their radio set. This simple switching arrangement permits radio reception, recording, reproduction of records or the amplification of "home talent" with a mike.

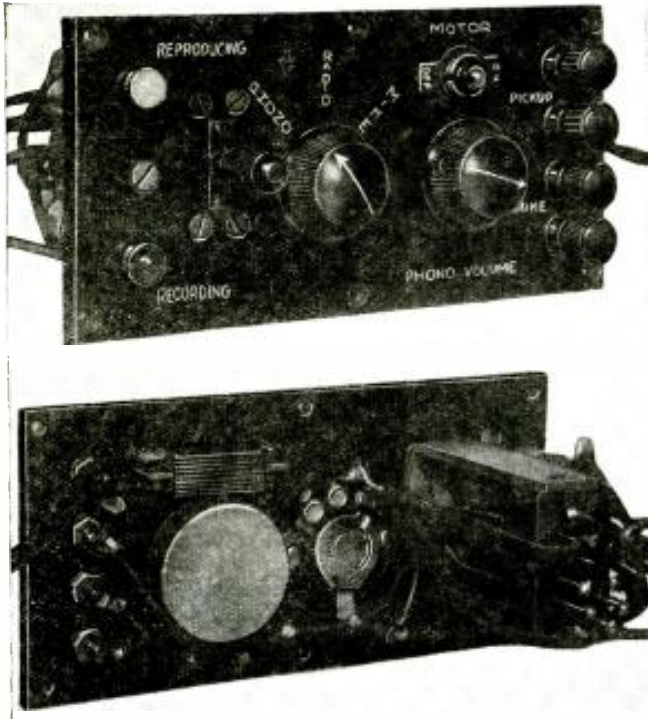

Fig. A, above; Fig. B, below
The front and rear views of the panel of the home-recording control unit.

JOSEPH LEEB

MOST articles describing the construction of home recording equipment do not seem to take into consideration the fact that the constructor may want to incorporate the apparatus as a permanent and integral part of his radio receiving set.

In response to this need, the author has designed a control panel, shown in Figs. A and B, which is simple, compact and which may readily be adapted to practically any radio set. The addition will greatly increase the convenience and pleasure of recording.

The control panel, of bakelite, etc., is very small, measuring but $2\frac{3}{4}$ x 6 ins. Despite its diminutive size, the panel contains a 3 point selector switch, an on-off motor switch, a volume control, a 12 point anti-capacity switch, red and green indicating light bezels and two pairs of binding posts.

Referring to the schematic diagram, Fig. 1, we see that the grid-return of the detector circuit has been opened to permit the insertion of either a phonograph pickup or a microphone input. The 4 pole double-throw anti-capacity switch permits us to set the circuit for either recording or reproducing. When thrown to the "reproducing" position, the indicating light under the green bezel lights up. With the aid of the 3 point selector switch, we can choose, for reproduction, either the incoming radio program, a phonograph record, or some home talent from the microphone. When the anti-capacity switch is set in the "recording" position, the red bezel becomes illuminated, the phonograph pickup is switched into the output of the last audio-amplifier stage and the voice coil circuit of the dynamic reproducer is opened. With the aid of the 3 point selector switch, we can now make a permanent record of the incoming radio program or any vocal or instrumental sound going into our microphone. In order to make a good record, it will be necessary to place an additional weight on the pickup head. A little experimenting will show the correct volume adjustments for the microphone and radio to give a good clean-cut record.

The microphone circuit, shown enclosed within a dotted line, is contained in a separate box. The reason for this is that it may be desirable, for best results in recording, to have the microphone located some distance from the radio—preferably, in another room.

The voltage source for lighting the indicating bulbs on the panel is the same winding on the power transformer that lights up the tubes in the set. The wires feeding the indicating lights should be twisted, in order to avoid the possibility of introducing a hum into the circuit.

The small size of the control panel permits it to be mounted directly upon the motorboard of the phono. unit in practically all cases. A hole is cut in the motorboard large enough to permit the parts to slip through, and the panel is fastened in place by means of wood screws.

A little attention to the details of wiring, both on the panel proper, and the circuits leading to it, may save much unnecessary trouble. The wire leading from the arm of the detector 3 point selector switch in the grid-return of the detector R.F. coil should be shielded, and the shield connected to ground. This wire may also have the effect of slightly unbalancing the tuning in the detector circuit. However, a slight readjustment of the detector trimmer condenser will effectively remedy this.

It will be noted that the voice-coil circuit of the speaker (Continued on page 493)

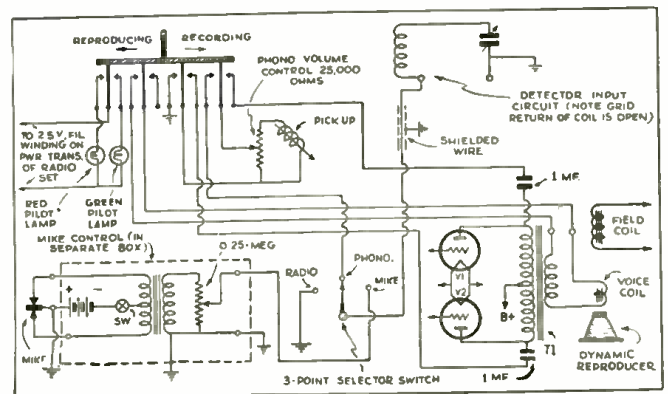

Fig. 1
The circuit showing connections to the set.

CONSTRUCTION DETAILS OF A NOVEL 9-TUBE ALL-WAVE "SUPER"

S. MILLER*

New ideas in short-wave and broadcast receiver design are incorporated in the chassis described by the author. A convenience to the constructor is the fact that the entire equipment is available completely mounted.

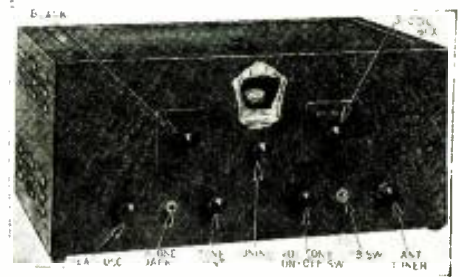

Fig. A
The appearance of the set with its six knobs.

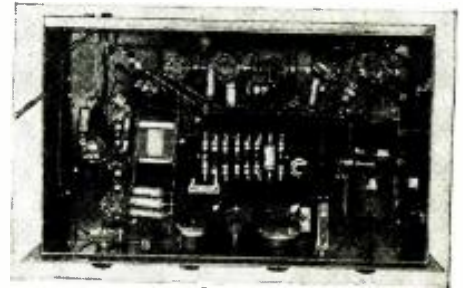

Fig. C
Underside arrangement of the components.

SOMETHING a bit different in all-wave receivers has at last "come down the pike." This instrument, illustrated in Fig. A, and connected as shown in Fig. 1, is a super-sensitive all-wave superheterodyne; constructors will be glad to know that it is available in mounted-kit form; that is, with all components mounted, ready for wiring.

Reference to Fig. B shows that five "coil boxes" are used to cover the wavelength range of 14 to 540 meters; the broadcast coil is designed for 10 kc. separation. Although coil details will subsequently appear, it is not recommended that these coils be home-made, since three circuits must be accurately aligned. This "drawer" method of wave changing not only eliminates dead-end losses but also makes convenient the change of three circuits; thus, one "coil box" may be used for band spreading when fully plugged into the receiver and, when pulled out one-half inch,

a second set of connections is made which results in full-band tuning. (The equivalent of 15 plug-in coils!) Each of the three shielding compartments includes a coil and its compensating and tracking condensers.

Circuit Features

Experimenters who have built superheterodynes are acquainted with the advantages of a stage of tuned R.F. amplification ahead of the first-detector; its use prevents image-

frequency reception and results in increased sensitivity on the high frequencies. However, receivers designed for operation at short wavelengths seldom have incorporated this additional tuned circuit as a part of single-dial operation, due to the difficulty of ganging the circuits at the higher frequencies. The "drawer" arrangement of the tuned inductances, however, makes this design very convenient for the average set

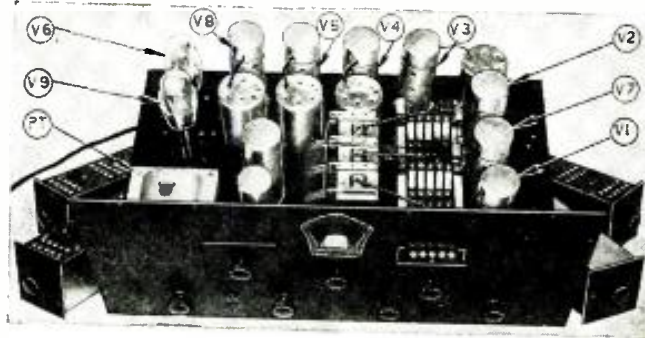

Fig. B
The interior of the receiver showing the parts.

*Chief Engr., Postal Radio Corp.

(Continued on page 487)

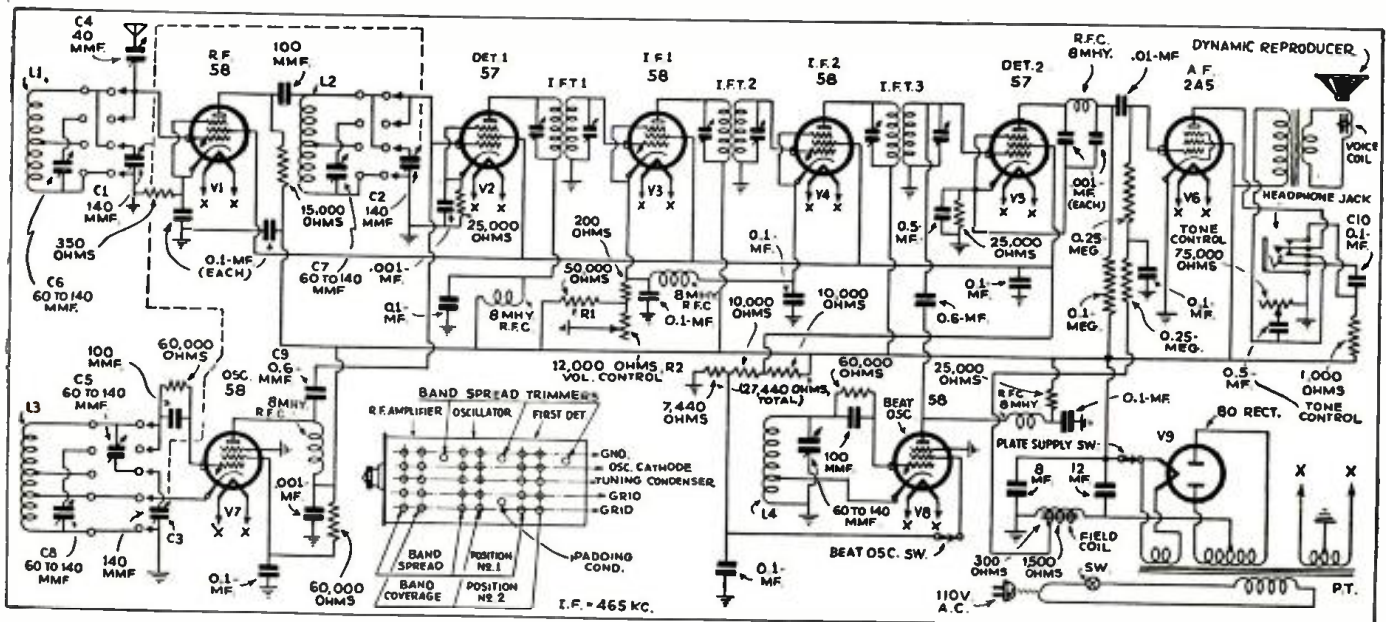
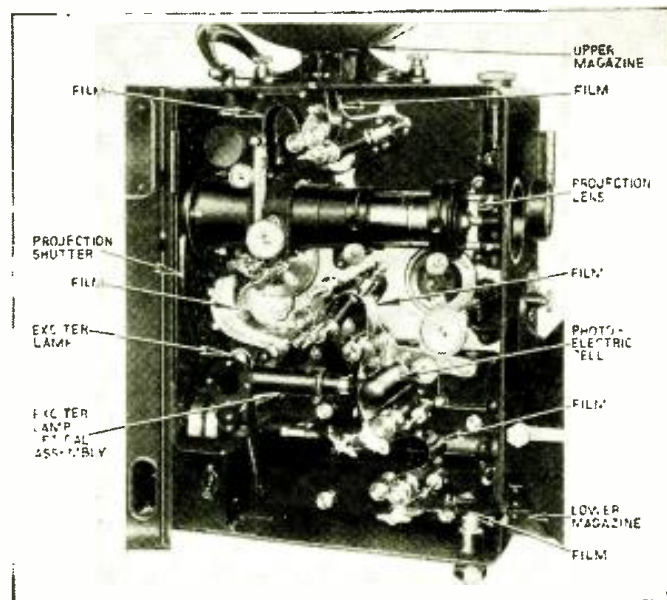

Fig. 1

The schematic circuit of the set, showing the advanced design. Band-spread or full-band tuning is achieved by shifting the coil drawers.

SERVICING THE "TALKIES"

In this article Mr. Nadell discourses on the exact relation of the radio Service Man to the commercial sound projectionist. Read this article—not only read it, but STUDY it carefully, then answer the questionnaire on the following page. Do you, or do you not want to seriously undertake the servicing of "talkies" equipment? If you are in earnest about entering this lucrative field, let's hear from you, via questionnaire.



The "innerds" of a standard Simplex projector.

PART IV

AARON NADELL

PRECEDING articles of this series have outlined the business opportunities awaiting radio Service Men and dealers in the field of talking motion pictures; and presented a brief, skeleton sketch of the nature of theatre talkie apparatus.

Now there are two men in any theatre the radio technician will have to "sell," and a refusal by either will be fatal to any of his plans. They are the manager and the projectionist, and a fair understanding of the viewpoint and habits of thought of those two gentlemen is as important to the radio man in search of theatre business as his understanding of sound apparatus itself. Sound apparatus can be studied in books, but there are no books that tell about the manager and the projectionist.

In accordance with the plan for this series, the present article will be devoted to the projectionist; the one following, to the manager.

After that, the radio reader will be prepared to consider and act upon concrete suggestions for approaching his community's theatres with definite and useful proposals, so presented as to secure the most favorable consideration.

The Radio Man and the Projectionist

The projectionist is the individual directly responsible for the operation and condition of the theatre's sound equipment, and the function of the radio technician in theatre work is necessarily one of cooperation with this man, *never* of competition with him. Any trace of the latter attitude will quickly end the radio man's usefulness to that theatre, for the projectionist "runs the show," and it is a literal fact that nothing can be done without his help and approval. The attempt to over-ride his point of view by appealing to the manager, who is officially his superior, was made some years past, by some of the electrical companies supplying sound equipment: it was a mistake. The projectionist will almost invariably cooperate with those who try to help him in his work, but has always proved an insurmountable obstacle to any who tried to come between him and his proper job. His good will is an essential with which the radio man cannot possibly dispense.

How to secure that good will? Well, first of all, the projectionist is not merely a mechanic, but a man who carries certain real and important responsibilities, and the most elementary principle of good manners in dealing with him is to recognize that fact.

The Responsibilities of the Projectionist

Some of the most important duties of this key man in any

theatre relate to the inflammability of motion-picture film. A reel of such film, tightly rolled up on a metal spindle, may fairly be described as explosive. More than one projection operator has lost his life trying to keep a sudden fire from reaching the audience. Prevention of fire, and of the panic that may be started by one, is not only a highly important part of projection room work, but often involves elaborate precautions rigidly prescribed by law. (On these grounds many projection unions, and the law in some communities, require the presence of two operators.)

The second large responsibility of the projectionist rests on the fact that he is the manufacturer who provides the goods that the theatre sells. He creates the show. He can ruin the best plot ever invented by breaks in the film, noises in the sound, or irregularity of his light upon the screen. And though he cannot make a good picture out of a poor one, at least he can, by a flawless presentation, give it every possible chance. He can often "dress it up" by projecting colored patterns around the title, by throwing it on a larger screen during mass scenes or spectacular climaxes, and by other methods known to his art. But he must do such things well, or they are worse than useless. In consequence, he is very largely the key to audience satisfaction or displeasure.

Thirdly, the manager or other actual head of the theatre is seldom a technician but commonly a business man (often one who doesn't know a vacuum tube from a porcelain cleat) and leans heavily on the advice of his projectionist in the matter of buying any form of technical equipment. Thus, the projectionist very often assumes, ex-officio, the responsibility of purchasing agent and maintenance advisor.

For all these reasons, there are comparatively few theatres where the management cares to go directly counter to the advice or wishes of the projection staff in technical matters. The educational and technical background of the average projectionist, as well as the special considerations involved in his union affiliations (if any) are, therefore, well entitled to an entire article in this series. In connection with that background it will be desirable to sketch very briefly the nature of projection equipment—as distinct from sound apparatus. This will also be advantageous because in some, troubles in projection machinery are reflected in noises or other disturbances in the sound.

Picture Projection

If the reader will hold his hand between a source of light and a wall, he will find the shadow cast is sharp and distinct when the hand is close to the wall, and blurred but enlarged when the hand is close to the light.

A "TALKIES" QUESTIONNAIRE — TO BE ANSWERED

RADIO MEN: Please send us your answers to the following questions. It will not be necessary to repeat the questions—just use the respective reference numbers.

- (1) Are you personally interested in the commercial possibilities of servicing sound-projection equipment?
- (2) What in your mind would be the most important handicap you yourself would have to overcome in selling service to theatres? The second important handicap?
- (3) Are you confident of your technical ability to handle sound equipment?
- (4) If not, is your lack of confidence due to lack of detailed knowledge—or what?
- (5) On what technical details would you desire further information?
- (6) On what commercial details would you desire further information?

As this information is required at once in order that the succeeding articles on servicing "talkies" will be of greatest benefit to all, we ask that you write—right now.

If, however, a suitable lens is placed between the hand and the wall, the hand may be held close to the light and the greatly enlarged shadow cast on the wall will nevertheless remain sharp and clean in outline. The lens, by preventing the light from scattering and lining it up as nearly parallel rays, permits the projection of an image over a large distance without the blurring that would otherwise be inevitable.

Instead of the hand, a piece of glass with words or pictures marked upon it may be held between the lens and the light, and the words or pictures will appear clearly on the distant wall, with

an exact reproduction of light and shade. However, unless the source of light is covered by frosted glass the shape of the lamp filament, for example, will also be projected on the wall; a little blurred because of being out of focus, but still distinct and capable of causing uneven illumination of the pictures or words. Frosted glass is too wasteful of light to be used in projection work; instead, a lens known as a "condenser" is placed between the source of light and the image to be projected. The condenser diffuses the light before it reaches the image, preventing projection of the shape of the light source,

and helping secure evenly distributed illumination over every portion of the screen.

Here are all the necessary elements for the projection of still, as distinct from moving, pictures—a source of light, a condenser to diffuse it, an image through which it is projected, and a lens to focus it upon a distant screen. These elements are often combined in a projection room device called a stereopticon. The stereopticon projects the words of popular songs, advertising signs, and other non-moving matter.

(Continued on page 494)

A 110 V., D.C. TUBE CHECKER ATTACHMENT

Use this attachment to your regular A.C. unit for testing tubes in "D.C." districts

L. W. HAASE

MANY Service Men have encountered the problem of how to check the tubes of a universal or D.C. set in the strictly D.C. section of his city. His portable tube checker usually contains a transformer designed to work only from the A.C. line.

Following is the description of an attachment to meet this condition. It may be used in conjunction with the milliammeter in the A.C. checker. Also, if the filament voltmeter is a moving vane type, and calibrated for A.C. as well as D.C.; it may be used to check the new high filament voltage tubes like the 43 and 48 on the A.C. line.

For the Service Men now rebuilding their equipment to meet the new crop of tubes, it will prove a boon. It solves the problem of how to obtain the high filament voltage required by some tubes.

(Continued on page 488)

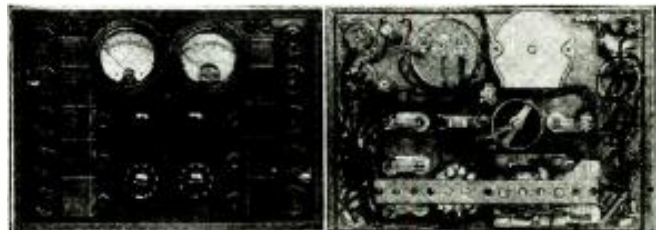

Fig. A, left; Fig. B, right
Front and rear views, respectively, of the 110 V. D.C. attachment.

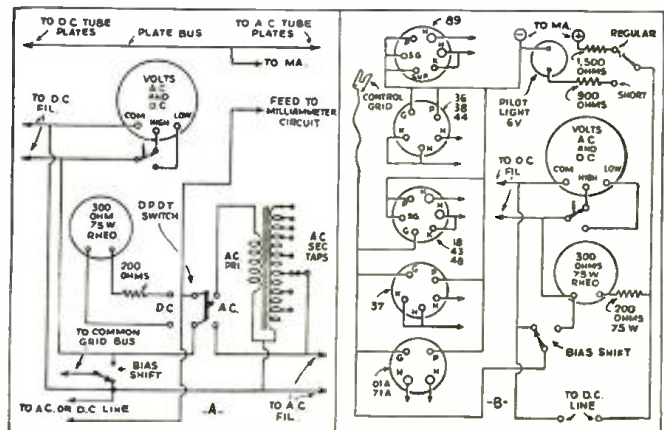

Fig. 1

Schematic circuits of the "D.C." tube checker.

THE ANALYSIS OF RADIO RECEIVER SYMPTOMS OPERATING NOTES

BERTRAM M. FREED

WHAT THIS DEPARTMENT IS FOR

It is conducted especially for the professional Service Man. In it will be found the most unusual troubles encountered in radio service work, written in a practical manner, by Service Men for you.

Have you, as a professional man, encountered any unusual or interesting Service Kinks that may help your fellow workers? If so, let us have them. They will be paid for, upon publication, at regular space rates.

ALTHOUGH the trend of modern receiver design has made imperative the need for more highly trained radio Service Men, even after the technical requisites have been mastered, it takes a certain amount of practical experience to really qualify as a first class Service Man. Ordinarily, the more experience an individual possesses the more capable and confident he is. It is true that the diagnosing of a radio set may only be a process of elimination, where checking each of the questionable circuits or components, in turn, will usually disclose the cause of an ailing receiver; but with radio service, time is the essence.

In commercial receivers, certain makes and models have definite points where the first weakness is most liable

to appear and the man who knows these tendencies can do the quickest and best job. One of the most valuable assets to the Service Man is his ability to observe and recognize these symptoms, for knowing beforehand the symptoms or effects of failure enables rapid analysis and repair. In the following paragraphs an effort will be made to discuss some of these symptoms and peculiar causes, and their remedy.

MAJESTIC 303, 304, 307, 324, 344, 363

IN these models a rather unique form of resonance indication is employed. Resonance is indicated by tuning the station selector to the station until the pilot light is dim. This action is secured by means of a 3 legged-triple-winding iron-core reactor. The center winding is in the plate supply circuit of the R.F., first-detector and I.F. tubes. The two outside windings are in series with the pilot light and are so connected that they will buck each other so far as the center winding is concerned, as shown in Fig. 1. Because of the A.V.C. action, when the set is switched on and the station selector is not tuned to a station, a relatively large plate current will flow through the center winding, saturating the iron-core so that the reactance of the two outer windings is low and the pilot light will light up brightly because of the added current passing through the outer windings. When the station selector is tuned to resonance,

the A.V.C. tube increases the control-grid bias of the R.F. first-detector and I.F. tubes, resulting in a decreased plate current being drawn by these tubes. The plate current flowing through the central winding is reduced, and the reactance of the outer windings increases, limiting the current flowing through the pilot light, which will dim upon resonance. This center winding, however, is the cause of many service calls. The winding open-circuits and the set becomes inoperative, necessitating replacement of the reactance unit. (Refer to page 287 of the November, 1932 issue of RADIO-CRAFT for a more detailed discussion of this reactance operation.—Assoc. Editor)

(Continued on page 495)

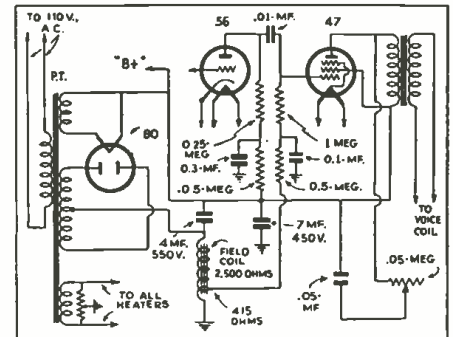

Fig. 2
The pentode output circuit of the Sparton 14 set.

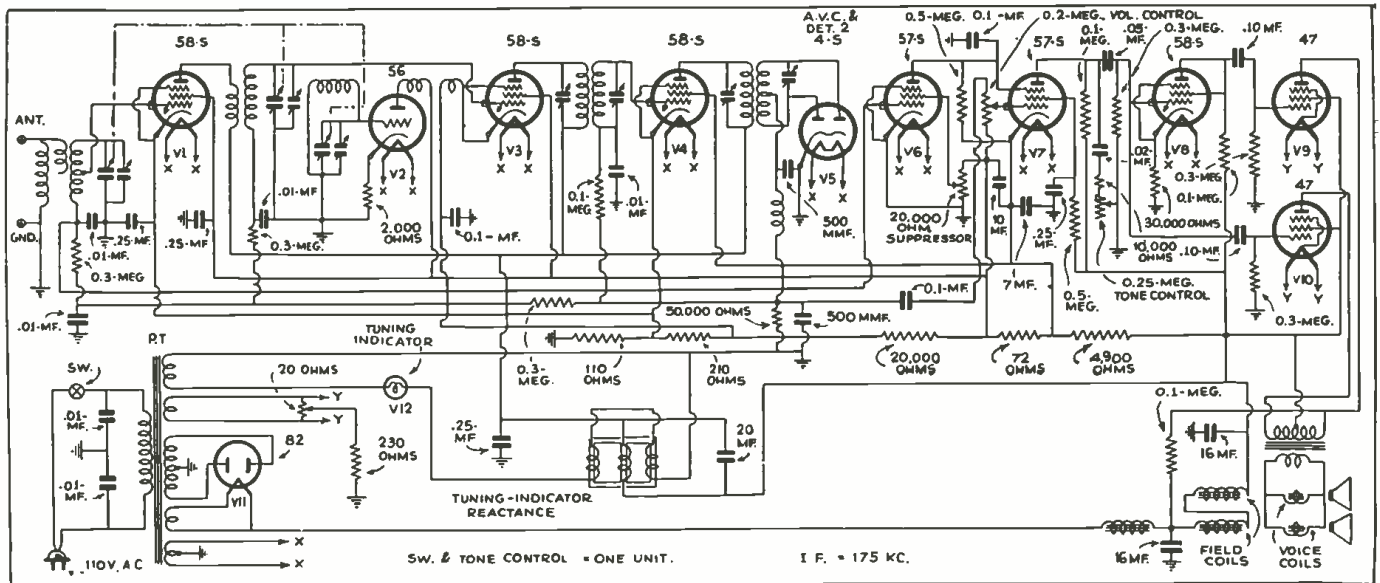

Fig. 1
The circuit diagram of the Majestic chassis models 300 and 300A, showing the "reactance-type tuning indicator" which sometimes causes trouble.

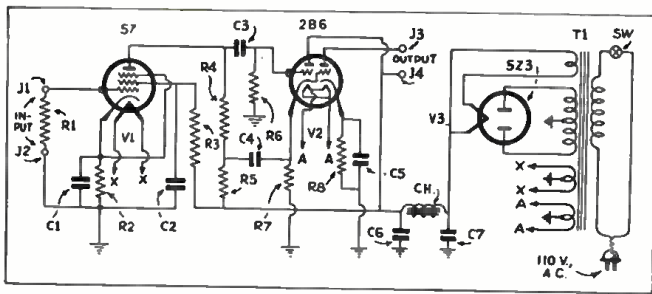

Fig. 1
Schematic circuit of the newest in direct-coupled amplifiers

CONSTRUCTING A 2 B 6 AMPLIFIER

First we had the "triple-twin" type 295 tube (RADIO-CRAFT, February 1932, page 455), then the "duplex-triode" type 2B6 (RADIO-CRAFT, September 1933, page 142); the latter, improved design is the basis of the simple, powerful amplifier described by Mr. Shortt.

F. V. SHORTT*

A LONG-STANDING hope of P.A. engineers has been realized with the development of this new amplifier, which takes advantage of the startling possibilities of the 2B6 power output tube invented by Chas. F. Stromeyer.

The writer recalls the intense interest created several years ago by the first little amplifiers operating on the Loftin-White principle. At the time, those amplifiers were sensationally unique, because they worked without expensive audio transformers and still had plenty of gain. Later as the new pentodes were introduced, compact two stage amplifiers were developed which were capable of operating 3 good-size dynamic reproducers.

However, this new unit makes all other 2 stage jobs seem like toys by comparison. This amplifier has an undistorted power output of 6 W. (peak 8 W.) and will operate from 4 to 5 dynamic reproducers! Furthermore, it takes less space than formerly required by more inefficient units; uses fewer parts and costs less. As a matter of fact, the output of this amplifier is greater than two 45's in push-pull!

The circuit employed, Fig. 1, consists of a 57 pentode tube, resistance-capacity coupled to the new 2B6 duo-triode. A 5Z3 full-wave rectifier is employed. The entire amplifier is assembled on a compact chassis, 8½ x 6 x 5½ ins. high.

The non-critical load conditions of the 2B6 tube result in extremely high fidelity. This feature, while always desirable, is especially valuable where the amplifier is used for recording purposes. The response curve has an exceptionally flat characteristic and the reproduction of both voice and music is absolutely natural.

80 db. Gain

The exceptionally high gain of 80 db. makes it possible to use this amplifier for all ordinary microphone purposes, without the use of a pre-amplifier. In spite of the high gain hum is practically eliminated, due to careful design of the

power supply system and also to the fact that both stages employ tubes of the cathode heater type.

Naturally, the 2B6 tube is the vital factor in accounting for the high power output, great sensitivity and low power consumption of this amplifier. This tube employs two sets of triode elements identified as the input and output sections. They are connected in such a way that the power required by the input circuit of the output section is automatically supplied by the input section.

Since the grid of the output section swings into the positive region of its grid voltage-plate current characteristic curve, power is required during part of the cycle. This power is supplied by the input section. The input-section grid is biased negatively and is not permitted to operate in the positive region of the grid swings. Hence, no input power is required.

The D.C. power taken by the steady state of the tube, with no signal input, is in excess of that required under maximum excitation. Hence, no complications in the power pack design are introduced. For these reasons, the amplifier operates as a true class A amplifier.

Deriving the Bias Voltages

Referring again to the schematic diagram, Fig. 1, it will be seen that the voltage across the 8,000 ohm cathode resistor, R7, determines the bias for the input grid. The output-grid bias is determined by the differences between the voltages across R7 and R8.

Since the output grid is internally connected to the input cathode, the positive bias on the grid is measured across the two cathode terminals. The grid is nominally 2½ V. positive with respect to its cathode; hence the grid conductance is appreciable. Therefore, the input plate current divides, part flowing through the output grid resistance and part through R7. Consequently, the current for determining the input-grid bias is measured between the input cathode and R7, not between the input plate and "B plus." The average D.C. flowing through R7 is 3 ma. This resistor also

acts as part of the input-section load impedance and, therefore, should not be shunted by a condenser. The complete load is the parallel combination of R7 and the grid impedance of the output section. It is of interest to note that the input grid does not draw current even though a 25 V. r.m.s. (root-mean-square or average value.—Assoc. Editor) signal is reached, while the grid is only biased 24 V. Under these conditions, the A.C. component of the voltage de-

Since the input voltage and this developed voltage are in phase with respect to ground, the voltage difference of

(Continued on page 496)



Fig. A
Front view of the 2B6-tube amplifier.

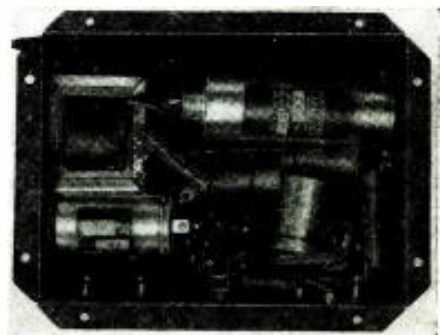

Fig. B
Underside view of a pre-production model.

* Chief Engineer, Wholesale Radio Service Co.

WURLITZER LYRIC MODEL SW88 8 TUBE ALL-WAVE SUPERHETERODYNE

(Incorporates the model SW80 chassis; range, 35.3 to 546 meters. Also, A.V.C.; and, calibrated wave-band selector and tuning dial.



This receiver has an output of 3 W. and is designed for extreme sensitivity and selectivity. Tube and circuit operating voltages, measured to chassis, are shown in parentheses. Four tuning ranges are selected by means of a 5 pole 4 position wave-change switch operated by the knob directly under the tuning control. This knob also actuates a sliding mask behind the dial scale so that only the graduations corresponding to the band in use are illuminated. The four ranges are as follows:

- (1) (top scale), 550 to 1,500 kc.—546 to 200 meters;
- (2) 1,450 to 3,700 kc.—207 to 81.1 meters;
- (3) 3,500 to 9,000 kc.—85.7 to 33.3 meters;
- (4) 8,500 to 22,000 kc.—35.3 to 13.64 meters.

To tune the I.F. system the output of the service oscillator should be connected between the control-grid connection of V1 and the chassis, the regular connection of the control-grid of V1 being removed. Adjust the 6 trimmer screws for maximum output as indicated on the output meter connected in the reproducer unit. Do not attempt to align the receiver by ear.

The first operation in the tuning of the R.F. system is the setting of the trap circuit in the antenna system. The condenser and coil of this circuit are directly under

the variable condenser towards the front of the chassis and the adjustment is accessible from the bottom of the chassis. This circuit is tuned to 485 kc. and serves to prevent the reception of interfering signals. As the service oscillator is arranged to operate at 485 kc., the receiver should be so tuned that the variable condenser is at its maximum capacity. Then, set the service oscillator at 485 kc. and adjust the circuit for *least response*.

In ganging the broadcast band, first set the oscillator padding condenser with the service oscillator adjusted between 550 to 600 kc.; then, the dial pointer should indicate this frequency. The oscillator padding condenser (fourth adjusting screw from right of chassis as viewed from the rear) should be adjusted for maximum meter reading. Then, reset the service oscillator at a point between 1,400 and 1,500 kc. and tune the set accordingly. Adjust the oscillator (trimming condenser (rear section of gang condenser) for maximum output. Note that of two positions the correct setting is the one in which the trimmer is set to lowest capacity (adjusting screw turned farthest to the left). Next, the trimmer of the front section of the variable condenser, first-detector circuit, should be adjusted to get the maximum output. The oscillator should then be set to some known frequency approximately 1,250 kc., the set tuned so that this frequency is indicated on the dial and the set adjusted to maximum output by bending the adjustable sections of the rotor end plate; repeat the process at 900, 700 and 500 kc.

To adjust the first short-wave band, tune the set to the harmonic of some broadcast station falling between 1.45 and 1.6 on the dial (the harmonic of a station operating between 725 and 800 kc.). The oscillator padding condenser for this range is the third adjusting screw from the right of the chassis—from the rear. Adjust this condenser so that the signal being used as a test standard comes in at the correct point on the dial.

The receiver should then be tuned to the harmonic of some broadcast station between 3.1 and 3.7 on the dial and the trimmer adjusting screw at the extreme left end of

the chassis (when facing the rear of the set) adjusted for maximum output.

For the second short-wave band, a similar procedure should be followed, adjusting the oscillator pad (the second adjusting screw from the right end of the chassis) so that a signal having a frequency of from 3.5 to 4 megacycles is received at the correct place on the dial calibration. In this case there are no adjustments to be made on the high-frequency end of the scale.

The adjustments for the last short-wave band should be made in the same manner as those for the first short-wave band. The oscillator pad (extreme right-hand adjusting screw, facing the rear of the chassis) being adjusted so that a test signal having a frequency of from 8.5 to 10 megacycles is received at the correct point on the dial calibration. The set should then be tuned to a signal falling between 17 and 22 on the dial and the trimmer condenser (second screw from the left end of the chassis, facing the rear of the set) adjusted to give the maximum output.

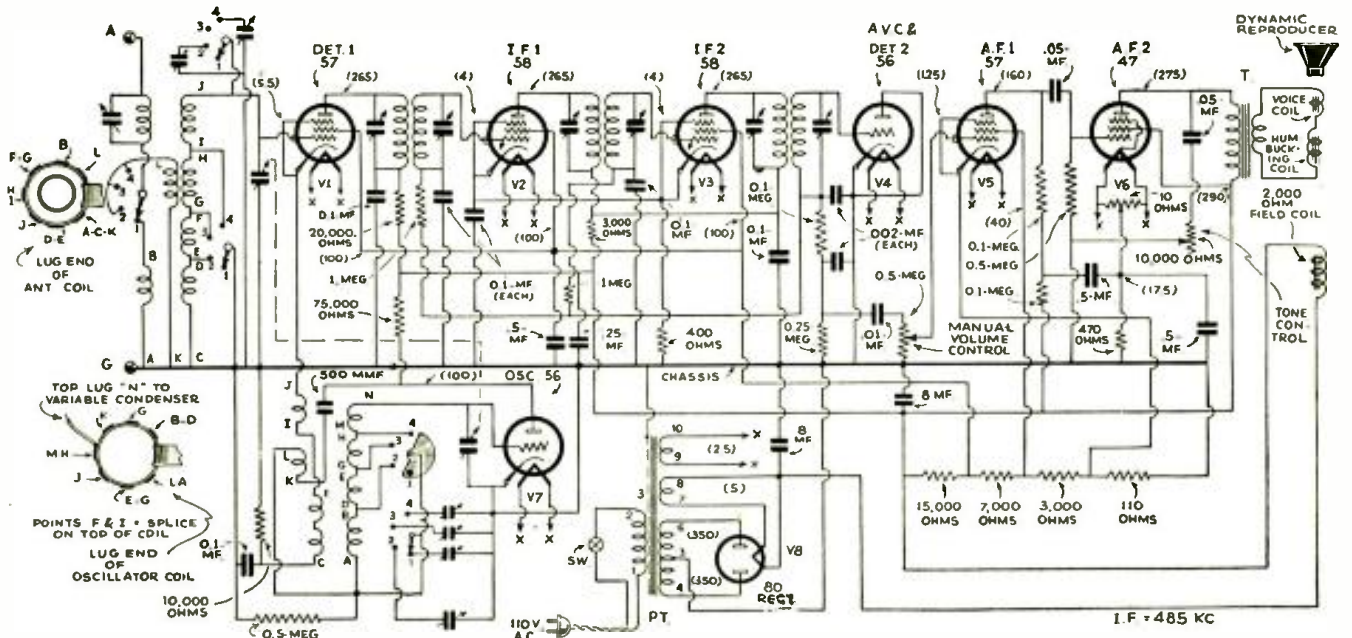
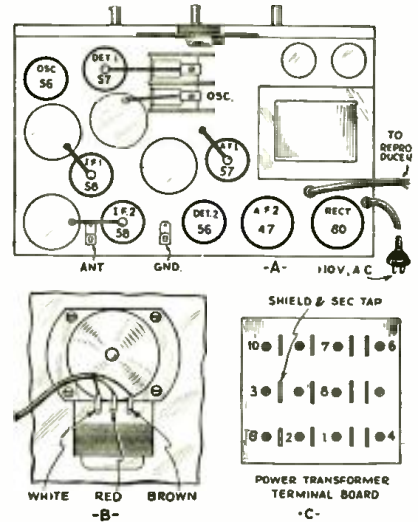

STROMBERG-CARLSON NOS. 55 AND 56 TE-LEK-TOR-ET 8 TUBE SUPERHETERODYNE

(Remote station selection; amplified A.V.C.; exceptional tone quality; tone controls)



10,000 ohms; R4, 16,000 ohms; R6, 300 ohms; R7, R13, R25, 15,000 ohms; R8, 14 ohms; R9, 47 ohms; R14, 1,000 ohms; R15, R19, R29, .25-meg.; R17, R18, 2,000 ohms; R21, R32, 2 megs.; R22, R23, 200 ohms; R24, 1000 ohms; R27, R28, .5-meg.; R30, 3,000 ohms; R33, 5,000 ohms; R34, 150 ohms; R35, 600 ohms.

Voltage readings are obtained by measuring between the various tube socket contacts and the bases with the tubes, speaker, and cable plug in place. Refer to the numbered illustration. The following figures are for a line potential of 120 V. and using a high-resistance meter. The volume control should be set to the full-on position.

Tube Type	1	2	3	4	5	6	7
V1	145	75	2.8	2.8	*	*	*
V2	145	75	142	—	2	3.5	*
V3	145	90	6.8	6.8	*	*	*
V4	145	90	0	6.4	6.4	*	*
V5	110	4	6.5	6.5	*	*	*
V6	260	260	0	17	*	*	*
V7	260	260	0	17	*	*	*
V8	280	300	300	280	*	*	*

* Heater voltages are read as follows: V1, 1/6, 6.3 V.; V2 1/7, 6.3 V.; V3, 1/6, 2.5 V.; V4, 1/6, 2.5 V.; V4, 1/7, 2.5 V.; V5, 1/6, 2.5 V.; V6, 1/6, 2.5 V.; V7, 1/6, 2.5 V.; V8, 1/4, 5 V.

The speaker socket measures as follows:

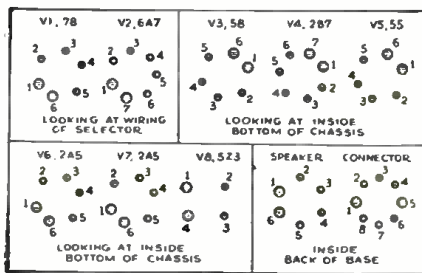

This "Te-lek-tor-et" system of control permits the operator to turn the receiver on and off, control volume, tune for any station on the dial or tune, just by "feel," any of a pre-selected group of eight stations. Contacts in the tuning mechanism automatically stop the tuning dial at the selected station. The constants of the components are as follows:

Condensers C1, image adjuster; C2, C3, C4, C5, C6, C7, C12, C28, C29, .05 mf.; C8, C23, .04-mf.; C9, series padder; C10, I.F. trimmer in remote selector; C11, C30, .001 mf.; C13, C14, C15, C16, C33, I.F. trimmers; C17, C18, C31, C32, C34, .3-mf.; C19, C36, C37, 8 mf.; C20, C21, C41, C43, 100 mmf.; C22, C25, C26, C35, 4 mf.; C24, C42, .2-mf.; C27, .004-mf.; C38, C39, .01-mf.; C40, thermostatic condenser in remote selector oscillator circuit; C44, .002-mf.

Resistors R1, R5, R11, R20, R26, .1-meg.; R2, R12, R31, 600 ohms; R3, R10, R16,

terminal 1, 0 V.; 2, +260 V.; 3, +270 V.; 4, +270 V.; 5, +130 V.; 6, 0 V.

Additional voltages may be measured directly across the correct terminals.

As the I.F. circuits of this receiver have been aligned at the factory by means of oscillographs, the re-alignment of the I.F. circuits should not be attempted.

One I.F. amplifier, V3, acts as a signal channel only, and the output is fed to the diodes of V5. The audio frequency currents resulting from the rectification of the diodes is fed through the triode portion of V5 which acts as an A.F. amplifier.

The other I.F. amplifier, V4, acts only as an "amplified A.V.C." channel. The I.F. output from the pentode portion of this tube is fed to the diodes of the same tube.

The D.A. voltage developed in the diode circuit is used for the A.V.C. voltage, and is fed back to the control grids of V1 and V2 through a conductor in the remote cable. A portion of this A.V.C. voltage is also applied to the control-grid of V3 to give a partial control of this tube.

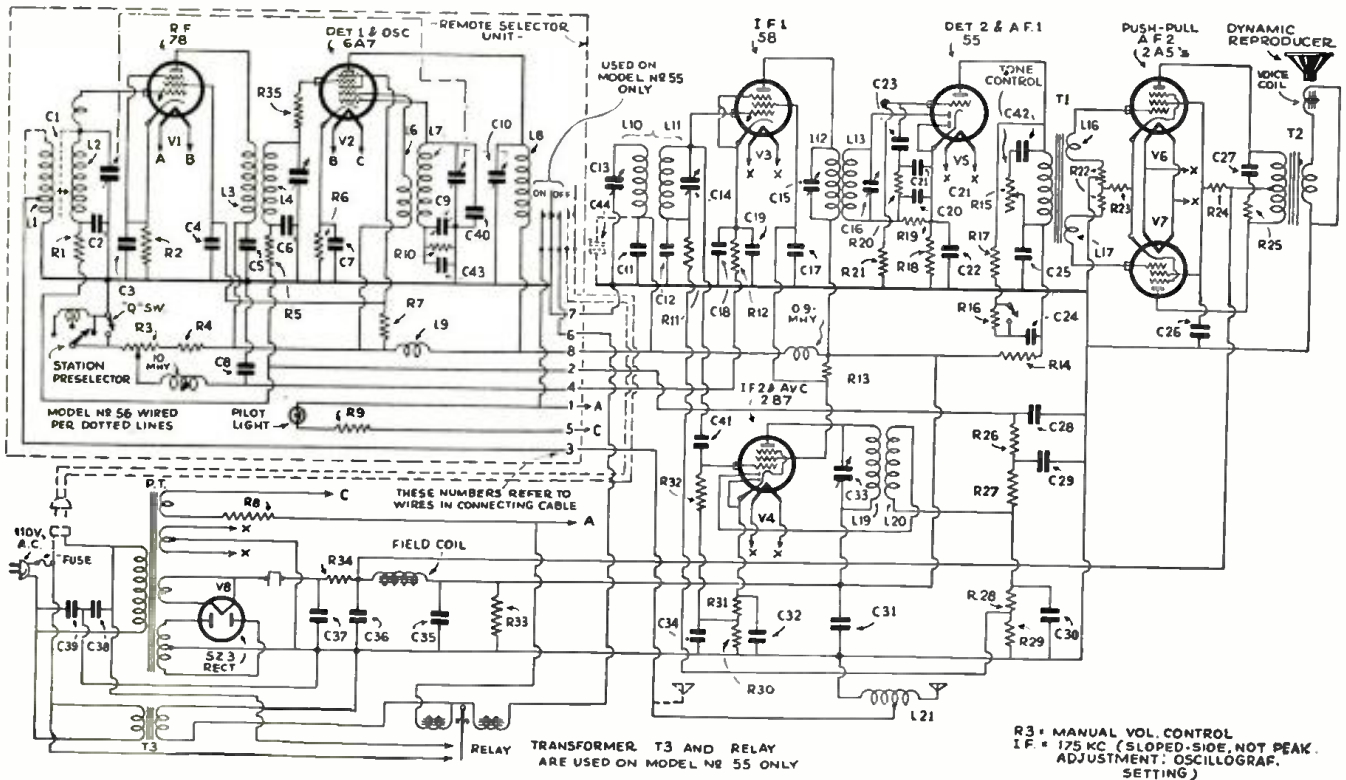

R3 = MANUAL VOL. CONTROL
I.F. = 175 KC (SLOPED-SIDE, NOT PEAK ADJUSTMENT; OSCILLOGRAPH SETTING)

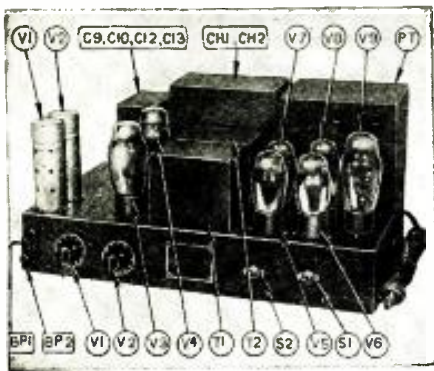

Fig. A
Duo-channel, 50 W. amplifier; front view.

THERE has at all times existed a demand for an amplifier system capable of delivering 50 W. of undistorted power, but the cost of purchasing or building and maintaining such a high-powered P.A. system has always been almost completely prohibitive!

In addition, 50 W. amplifier systems designed prior to the introduction of new tubes and systems, present many electrical and mechanical "handicaps."

Comparative Costs

Let us consider first the relative differences in cost between previously designed "50 watters" and the new model illustrated in Figs. A, B and 1, first stating facts and later exemplifying them in detail.

Average Comparative Specifications

Design Factors	"Old" 50 W. Unit	"New" 50 W. Unit
Power consumption, full load	500 W.	150 W.
Power consumption, aver. load	500 W.	125 W.
Power consumption, no load	500 W.	105 W.
Available channels	1	2
Weight	140 lbs.	51 lbs.
Size	18x20x9 in.	18x10x9 in.
Number of stages	3	4
Cost of tubes	\$65	\$10

* President, Coast-to-Coast Radio Corp.

CONSTRUCTING A 6 V. D. C. AND 110 V. A. C. (DUO-CHANNEL) 50 W. P. A. SYSTEM

LOUIS GANCHER*

Last August we described a 20 W. unit, the first of a series of amplifiers designed to operate optionally on 6 V. D.C. and 110 V. A.C. A 26 W. design, Part I, appeared in the September issue; Part II in November; and Part III in December. The 50 W. amplifier described below incorporates still newer design features.

PART IV

Cost of amplifier (approx.) \$200 \$85

Inasmuch as this amplifier draws only 150 W. at full load, it can be operated from any 12 V. D.C. rotary converter producing 110 V. A.C., supplying 150 to 170 W. output.

(For dual-powered operation, dynamic speakers and phonograph motors are available for optional operation from either a 6 V. D.C. or a 110 V. A.C. power source.)

Employs Class B Tubes

The selection of the 53 type tube for the output stage was a matter of logical sequence, inasmuch as it combines in one tube every desirable performance characteristic, providing the following features:

- (1) Production of high volume output, requiring low plate voltage;
- (2) Low plate voltage insures minimum breakdown;
- (3) The closest approach to class A power output;

- (4) Low plate current consumption;
- (5) Optional operation from a 6 V. D.C. motor-generator;
- (6) "Indirect heater" tube (cathode type) precludes hum;
- (7) Rugged internal element design assures long life operation.

The first two A.F. tubes, of the 37 type, were selected to permit optional operation on 6.3 V., A.C. or D.C. If 6 V. D.C. operation is not contemplated these two tubes may be replaced by the 56 type.

To secure an output of 50 W., previous amplifier designs usually used a tube complement about as follows: one type 56 tube; two 59's; one 80; two 845's; and two 866's.

Flexible P.A. Amplifier

The circuit used consists of two stages of resistance-coupled amplification branching off to two individual channels, each one of which employs its own "driver" and pair of twin class B power output tubes as shown in Fig. 1.

(Continued on page 499)

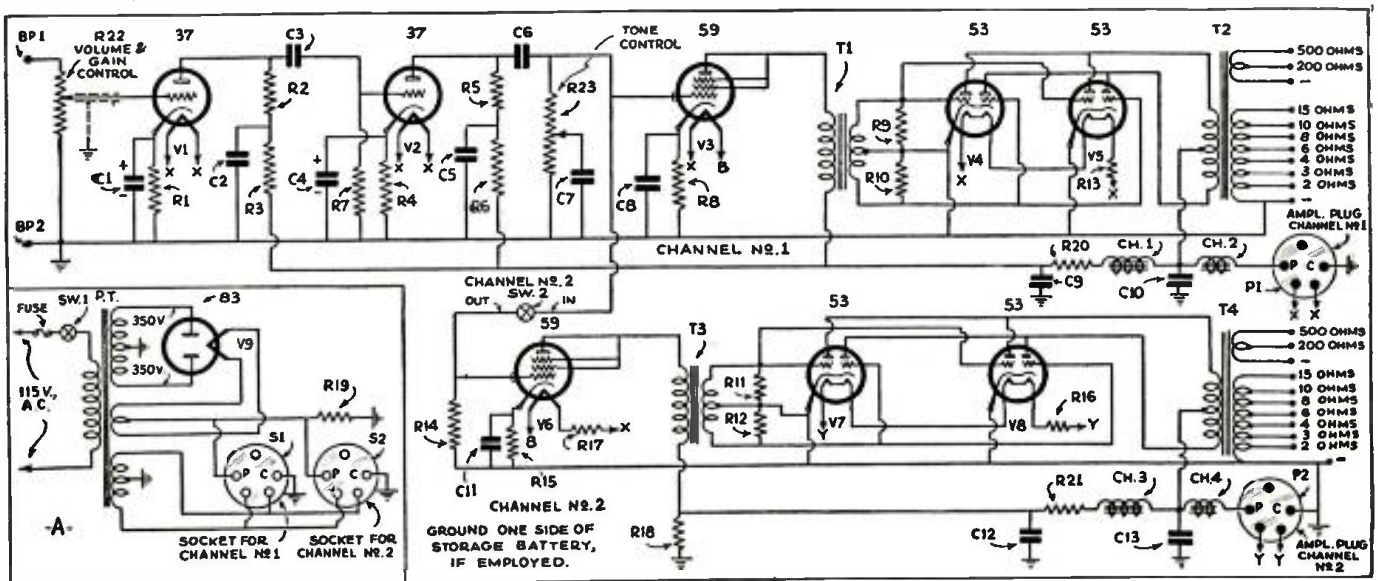

Fig. 1

Diagram of the "last word" in high-power P.A. systems for optional 6 V. D.C. and 110 V. A.C. operation. "Coverage" is sufficient for an audience of 6,000!



Radio's GREATEST Servicing Book

The Most Complete Directory of Radio Circuit Diagrams published!

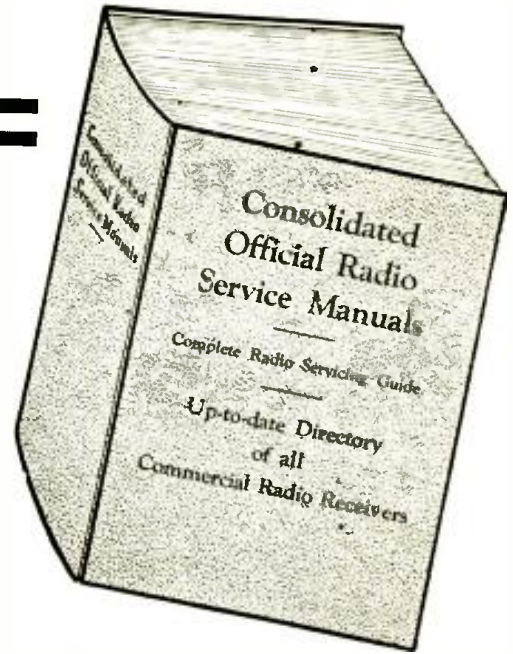

**In ONE VOLUME of over 2,300 Pages
Extra Heavy Cover—Looseleaf Bound**

Buy this Big Volume on our *New*

DEFERRED PAYMENT PLAN

Here are two of the most surprising announcements that we have ever made to the radio trade and we know that it is such good news that every radio man will be greatly enthused.

FIRST—that the three editions of the OFFICIAL RADIO SERVICE MANUALS have now been combined into one big volume of over 2,300 pages.

SECOND—that this new single volume of consolidated radio circuit diagrams and complete radio servicing course can be bought on a deferred payment plan—and at a big saving.

It is needless to say how valuable the OFFICIAL RADIO SERVICE MANUALS have been to members in every branch of the Radio Industry, and how many thousands of each edition have been sold to manufacturers, jobbers, dealers, Service Men and experimenters. But we must emphasize this one fact: Service Men now realize that they are tremendously handicapped without the full set of Gernsback Manuals. So much so, that those who have purchased only one or two volumes, are NOW ORDERING THE MISSING BOOKS. They want their files to be complete.

The complete book gives you a volume of over 2,300 pages with over 5,500 diagrams, charts and photos. There are absolutely no pages or illustrations or diagrams duplicated. There is no radio book published today which is so modern, up-to-the-minute, and which contains so much useful information as is to be found in this single volume. It is a book that will outlast any other radio book in print. Look carefully at the illustration of the complete edition on the top of page. It measures 9" wide, 12" long, 4 1/2" thick.

Included in this volume is a complete radio servicing course. This course covers every step needed to learn the servicing business . . . from starting in business . . . materials needed . . . and how to go about servicing receivers and repairing other radio equipment. This course in itself, is actually worth the price of the entire book.

Our new plan now enables every radio man to get this single volume—a Complete Directory of all Circuit Diagrams, of over 2,300 pages, on deferred payments. You can order this book immediately—get it in a few days, and use it while you are doing servicing work. You can make the first few calls pay for the entire cost of the book.

For you to get this book is quite simple and it is sent to you as soon as your order is received. You pay for it in small monthly amounts which can be taken from your earnings. If you were to buy the three volumes separately, the total cost would be \$17.00, including the supplements.

Now you can get the
1931 OFFICIAL RADIO SERVICE MANUAL, with Supplements,
1932 OFFICIAL RADIO SERVICE MANUAL, with Supplements,
and the 1933 OFFICIAL RADIO SERVICE MANUAL Complete

at a big saving.

THE SPECIAL NEW PRICE FOR ALL THREE MANUALS, WITH SUPPLEMENTS, IN ONE VOLUME, WITH HEAVY BINDER IS ONLY

\$14.00

You buy this book this way—
Send \$3.00 with order—
Pay \$5.00 to Express Company upon receipt of book.

Send \$3.00 thirty days after receipt of book.
Send \$3.00 sixty days after receipt of book.
Total \$14.00.

IF THE ENTIRE AMOUNT IS SENT WITH YOUR ORDER, WE WILL ALLOW YOU A 10% DISCOUNT. THIS CAN BE DEDUCTED FROM YOUR REMITTANCE.

IMMEDIATE SHIPMENT

**OVER 2,300 Pages
5,500 Illustrations**

THIS IS THE GREATEST SINGLE VOLUME RADIO BOOK IN PRINT TODAY

GERNSBACK PUBLICATIONS, Inc.

96-98 Park Place

New York, N. Y.

Mail Coupon Today!

GERNSBACK PUBLICATIONS, Inc.,
96-98 Park Place, New York, N. Y.

Gentlemen:

In accordance with your Special Offer, I enclose herewith \$3.00 as first payment toward the One-Volume Radio Manual. Please forward it to me promptly. Upon receipt of the book, I shall pay express company \$1.00. Thirty days later I shall send you \$3.00, and sixty days after receipt of book, I shall send you my last payment of \$3.00. If you want to take advantage of the Special Discount of 10%, remit only \$12.60 with this coupon.

Name

Address

City State RC-234

RADIO-CRAFT'S INFORMATION BUREAU

SPECIAL NOTICE TO CORRESPONDENTS: Ask as many questions as you like, but please observe these rules:

Furnish sufficient information, and draw a careful diagram when needed, to explain your meaning; use only one side of the paper. List each question. Be SURE to sign your name AND address.

Those questions which are found to represent the greatest general interest will be published here, to the extent that space permits. At least five weeks must elapse between the receipt of a question

and the appearance of its answer here.

Replies, magazines, etc., cannot be sent C. O. D.

Inquiries can be answered by mail only when accompanied by 25 cents (stamps) for each separate question; answers are subject to subsequent publication, if considered of exceptional interest. Other inquiries must be marked "For Publication."

TYPE 1A6 TUBE DATA

(232) Mr. H. P. Zurn, York, Penna.

(Q.) The prong and socket layouts of the new 1A6 2 V. tube as described in the November, 1933 issue of RADIO-CRAFT do not agree; which is the correct one?

If the prong diagram of Fig. 2B in the December, 1933 issue, page 268, of Grids 1 and 2 is correct, then the positions of these grids must be reversed in Fig. 1 on page 296 of the November, 1933 issue.

(A.) We are printing on this page (Fig. Q.232) a corrected diagram of the socket layout for the illustration that appeared on page 296 (RADIO-CRAFT, November, 1933). It will be noticed that the designations on Grids 1 and 2 have been reversed and now agree with the diagram in the following (December) issue.

GANG CONDENSER APPLICATIONS

(233) Mr. Louis Minatel, Indianapolis, Ind.

(Q.) I have a 3-gang condenser which was made for tuning a superheterodyne set, but I want to use it on a T.R.F. job. Can you tell me if this is possible; and if so, how?

(A.) There are two general types of gang-type condensers in use in superheterodynes, today. The first of these contains individual condenser sections that have *similarly* shaped plates. In other words, this type of condenser consists of identical units ganged. In this type of condenser, "padding" circuits are used to permit the oscillator tuning condenser to cover the required frequency band which, as you know, is not the same as the other tuned circuits in the set.

The second type of ganged condenser uses individual sections that have *differently* shaped plates. In other words, the oscillator section does not have the same shape plates as the other sections which permits the latter circuit to cover the required band of frequencies without resorting to "padding" circuits.

All this explanation is for the purpose of telling you that if the condenser that you have has individual sections that are identical in shape and number of plates, you can use it in a T.R.F. set with no difficulty. You cannot use the other type of condenser conveniently for this purpose.

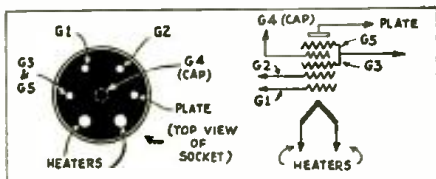

Fig. Q.232, above, Fig. Q.238, right. The correct socket layout for the 1A6 pentagrid converter is shown above.

The circuit diagram of the RCA-Victor model AR5006 ultra-short-wave receiver for mobile use appears on the right. It will be noticed that an extensive filter system prevents interference in the power supply unit from affecting the operation of the receiver. A noise suppressor controls the signal-to-noise ratio by varying the sensitivity.

VOLTAGE ON TUBE PLATES

(234) Mr. Fred Oestreich, Chicago, Ill.

(Q.) I have just built the Triple-Twin receiver described in the April, 1932 issue of RADIO-CRAFT. I have received fine results except that with the tickler coil inserted loud whistles and screeches begin. With the tickler coil removed, the stations come in two and three at a time, without the objectionable noises.

I measured the plate voltage on the type 27 detector tube and the needle barely flickers. I used the ordinary "B" battery voltmeters. What causes the set to operate on such low plate voltage? Does this affect the output of the receiver in respect to volume?

(A.) The Triple-Twin receiver is a regenerative set, and like all sets of this type, it is subject to whistles when tuning, if the amount of regeneration is not carefully controlled. We believe that if you will practice tuning the set with the tickler coil in the circuit, that you will soon learn how to operate it without the annoying whistles. Try reducing the number of tickler turns.

Regarding the measurement of plate voltage on this receiver, a voltmeter such as the one you used is not practical, as it has a low resistance and for this reason draws so much current from the rectifier tube that its output is reduced, which accounts for the extremely low voltage indicated.

To measure the plate voltage of a receiver which obtains its power from an A.C. power unit, it is necessary to use a voltmeter with a very high internal resistance. In other words, a very sensitive meter movement with a high-resistance multiplier to increase the range to the desired maximum.

Such meters are said to have a resistance of 1,000 ohms per volt, which would make a total resistance of .25-meg. (250,000 ohms) for a 250 volt scale. (The above resistance per volt is the usual sensitivity for instruments used for radio work.)

ULTRA-MODERN SUPERHET.

(235) Mr. N. J. Dwyer, Woodside, L. I., N. Y.

(Q.) I am an amateur set builder, new to the radio game, and decided to build the Ultra-Modern Superheterodyne receiver de-

scribed in RADIO-CRAFT (October, 1932 and October, 1933), for the purpose of getting acquainted with superhet. circuits.

Having finished the set, tuned the intermediates to 175 kc. and adjusted the R.F. trimmers, I find that the set has no volume. It has selectivity to a certain extent but no power to enable it to pick up distant stations at any volume. I have gone over the circuit and find it wired correctly. The voltage between the plate and filament of the 2A5 tubes is in excess of 300 V. but when it is reduced the volume is cut down. Can you help me?

(A.) It is evident from Mr. Dwyer's description that his set is not aligned correctly. The procedure for aligning a superheterodyne receiver is not an easy thing for a person not well acquainted with this type of circuit.

As the adjustment of a set such as the Ultra-Modern Super requires the use of a calibrated oscillator, we advise Mr. Dwyer—as we have every other superhet. builder—to make an oscillator and calibrate it, before he makes any serious attempt to tune-up the set. Constructional details for making and calibrating simple and effective service oscillators have appeared in past issues (RADIO-CRAFT, August 1932, page 90), where reliable aligning instructions will also be found. Extensive information on aligning procedure also has appeared in numerous issues of the RADIO-CRAFT *Data Sheets*. Also see, "The Superheterodyne Book," by Clyde J. Fitch.

V. T. VOLTMETER DATA

(236) Mr. Joseph E. Soos, Passaic, N. J.

(Q.) Some time ago, I picked up one of my RADIO-CRAFT magazines and in it I found a circuit of a dynatron vacuum tube voltmeter. The instructions did not include a calibration chart or details for making the calibration. Will you please tell me how I can calibrate my meter?

(A.) Information concerning the calibration of vacuum tube voltmeters has appeared in past issues (RADIO-CRAFT, February 1932, page 466 and 493). We give a magazine reference as the information therein given is far more extensive than we could include in an item in this Bureau.

(237) Mr. S. M. Lockwood, Chicago, Ill. (Continued on page 501)

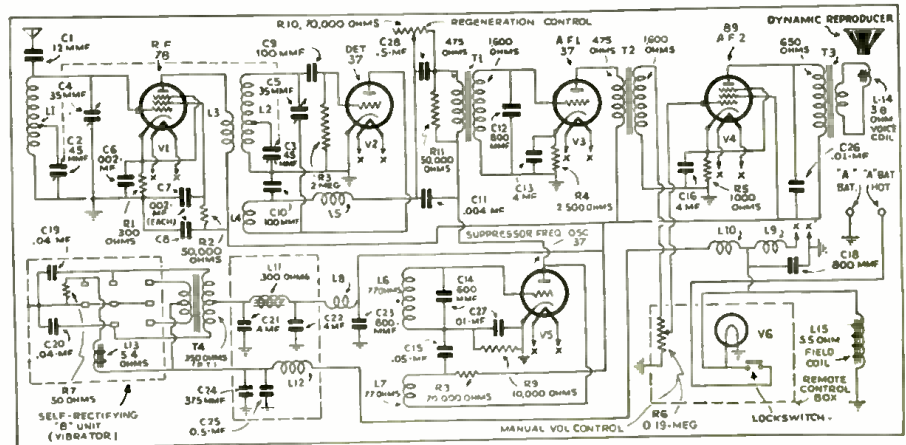

THE RADIO MONTH IN REVIEW

(Continued from page 455)

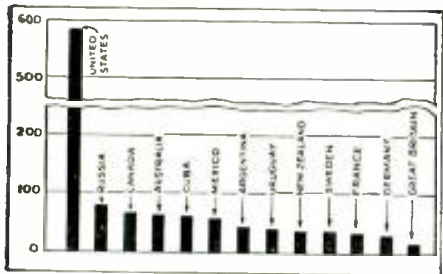

A SUMMARY OF THE BATSON REPORT

Uncle Sam has reduced the number of his "air voices" from well over 600 to 585.

THAT BROADCAST SITUATION

ONE of the wide-awake boys in the electrical division of the Department of Commerce, Lawrence D. Batson by name, has just completed a survey of the broadcast facilities throughout this little old world of ours. There are some very interesting facts hidden away in friend Batson's list. Uncle Sam has reduced the number of his "air voices" from a number well over 600, representing more than half the world's total, to the present number of 585.

However, while the U. S. has seen fit to diminish the number of broadcast "outlets" (as the experts at NBC aptly term their chain stations) most of the world has been busy increasing their number.

The Batson list shows the newly recognized country of Russia as ranking second to the United States. They boast of 73 stations, some of which are among the largest. Canada is third in the list, with 63; the continent of Australia ranks fourth with 60; Cuba, 57; Mexico, 53; Argentina, 35; Uruguay, 33; New Zealand, 32; and Sweden, 32. This does not take into account France, with 29; Germany, with 26; and Great Britain, with 12. The last-mentioned World power is reorganizing its broadcasting structure which accounts for the small number of stations. However, they are substantially more powerful than when wily John Bull had more.

As an aftermath of the late lamented Mexico City conference (RADIO-CRAFT, January 1934, page 390) a Waterbury, Conn., newspaper has sent a request to the boss (Federal Radio Commissioner LaFont) for a license to broadcast with unlimited time on 1520 kc. (well below the former broadcast frequency limits). Gen'l Commissioner LaFont has not yet given a disposition of the case, but in the editor's humble opinion, no answer will be found to the problem until a definite settlement of the frequency allotment question has been reached (RADIO-CRAFT, January 1934, page 390).

SUN SPOTS AND MOON RADIUM

WE have all been hearing much about cosmic rays, sun spots and the-like, during the past year and probably wondered what they are all about.

And now comes another scientist and astronomer, Dr. Harlan T. Stetson, of the Perkins Observatory at Ohio Wesleyan University, who complicates the situation still further by telling us that the moon also affects radio reception—as though sun spots, static, interference and cosmic rays were not enough!

In reply to an inquiry by the editor Dr. Stetson says: "researches in the investigation of the correlation of solar activity with radio reception have been made continuously at the Perkins Observatory on the intensity of radio reception from WBBM, Chicago, since the early part of 1930. After correction for the twilight factor and the major trend of change

Poor Tubes Ruin Radio Reception



"BULLEEVE ME!" New tubes do make a difference when you listen to Fanny Brice.

New RCA Tubes Improve Radio Reception

5 amazing RCA

TUBE IMPROVEMENTS

that put new life in your Radio

Don't buy any tubes today without knowing that you are getting these 5 remarkable improvements that will really put new life in your set! These great advances have come out of the RCA Radiotron Company's laboratories, developed by world-famous engineers for you. You get them in RCA Radiotrons and Cunningham Radio Tubes ... and these two tubes are the only ones actually made and guaranteed by RCA Radiotron Company, Inc., to give you these 5 great improvements.

Have your dealer test your tubes. Replace the worn-out ones with these new tubes. You will get a new thrill out of radio. RCA Radiotron Company, Inc., Camden, N. J. A Radio Corporation of America subsidiary.

HERE ARE THE 5 POINTS

- 1 Precision Construction** ... makes every tube a "matched" tube.
- 2 More Efficient Cathodes** ... assure uniform performance throughout life.
- 3 Improved Heater Design** ... reduces hum, eliminates noise from heater-cathode circuit and gives quick action.
- 4 Higher Vacuum** ... results in quieter operation.
- 5 Cooler Grids** ... prevent fluctuation in volume due to erratic tube performance.



Cunningham Radiotron



Every Needed Fact, Figure, Formula
Every Shortcut and Special Method
in the
WHOLE FIELD
of
MATHEMATICS

Now in ONE
Handy Volume!

For the first time you can have this wealth of practical mathematical information, covering every trade and business, condensed into one handy book for quick reference. This volume puts right at your finger tips instant facts and formulas for making every kind of mathematical calculation. From hundreds of different sources, this priceless information has been gathered together, boiled down into brief, simple language, and applied to actual problems. Every man in business, every man in the mechanical trades, every man who ever uses a tool or has to make calculations or estimates in office, shop, or home, will find here a treasury of money-making, money-saving ideas.

**THE HANDBOOK
OF APPLIED
MATHEMATICS**



No previous knowledge of mathematics is needed. No study is required. The specific information you want is easy to find, by looking it up in the index. The book takes up every trade and gives you practical methods, easily worked formulas for solving every problem. Thousands of specific examples show you just how to make your calculations. If your work involves mathematics in any way this complete reference handbook is an indispensable part of your equipment. It is an amazing timesaver for any one concerned with engineering, architecture, electricity, mechanics, construction, automobiles, machinery, printing, or any other industrial work; or with accounting, auditing, manufacturing, costs, taxes, or any other business mathematics. No practical man, no house owner who makes an occasional repair, no one who has a home work-shop can afford to be without the valuable information quickly found in this book.

**Save
17 1/2%**
on this
**Special
Advance of
Publication
Offer**

The regular price of this book will be at least \$6.00, and probably more. If you reserve your copy now, you may have it for only \$4.95. Easy payments if you wish. **Over 800 Pages.** 375 Illustrations. 150 Tables. Durable Maroon Fabric-bound.

**Save Time—Be
Sure of Your Facts**

One quick turn to the index and you find at once the best mathematical methods for solving your problems. You avoid the expensive errors that handicap the man who merely guesses. Think what an advantage it is to have all this information in one handy book! Take advantage of this opportunity to examine the book as soon as it is published, and save 17 1/2% of the regular price.

**EXAMINE THIS BOOK FREE
SEND NO MONEY—MAIL THIS COUPON**

D. VAN NOSTRAND CO.,
250 Fourth Ave., New York.
Send me as soon as published *The Handbook of Applied Mathematics*, at the Special-Pre-Publication Price. Within 5 days after I receive the book, I can return it and owe nothing. If I keep it, I will make a first payment of \$1.25 and I will pay \$2.00 monthly thereafter for 2 months—\$5.25 in all. (Cash with order \$4.95).

R.C. 2-34
Name
Address
City State
Reference
Address



MOON RADIUM RECORDING EQUIPMENT
Where Dr. Stetson discovered the effect of the moon on radio.

in radio due to sunspots, the hourly measurements of field intensity here have been compared with the moon's hour angle and declination, giving the results exhibited in the accompanying curves. This appears to be unmistakably a case of lunar influence of the electron density in the Kennelly-Heaviside layer. The change is so great that it hardly appears that the small gravitational tide in the earth's atmosphere is sufficient to explain the results. We pretty definitely know that the lunar surface is largely volcanic lava.

"Recent reports from the Geophysical Institute at Naples show that the underlying volcanic turfa there is more radioactive than pitchblende. This is what suggested my hypothesis that the moon may be emitting radioactive radiations which penetrate the earth's atmosphere to the upper reaches of the Kennelly-Heaviside layer, thus directly affecting the intensity of radio reception as our observations exhibit."

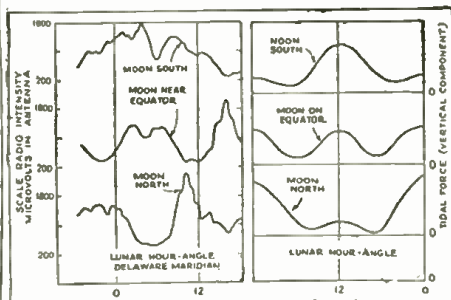

SOME PROOF OF THE MOON RADIUM THEORY
The relation between tides and radio.

LATEST IN RADIO

(Continued from page 459)

one band to another is accomplished and also how the potentials are applied to the filament and plate circuits.

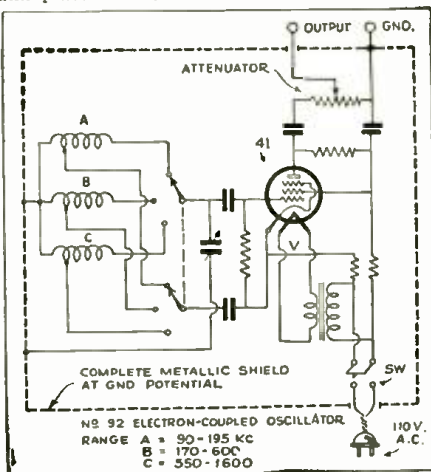

The diagram of the oscillator.

It is interesting to note that while no harmonics are used in the band from 90 to 1500 kc., that by the use of harmonics, the frequency band can be increased to much higher values. This is done by using the highest frequency coil and running a new calibration curve for the first, second, etc., harmonics, by which most of the "short waves" can be covered. Calibration curves are not available for the latter service but must be made by the operator to suit individual oscillators.

COUNTER-TYPE CHECKER



A simple tube checker (No. 402).

The tube tester presented above is very simple in operation, as all tubes with the same number of prongs are tested in the same socket. Thus there is no need for complicated charts or instruction sheets.

The unit supplies filament voltages from 1 1/2 to 30 V., and provisions are made to check duplex-diode and other combination tubes. A large meter in the center of the panel indicates the condition of the tubes and also shows the applied line voltage.

To take care of the future, an 8 prong socket is wired into the unit.

AIRPLANE RADIO RECEIVERS

Two radio sets designed for use in aviation have just been introduced. The first operates from a 12 V. battery supply and is made small and light for use in airplanes. This set is described on page 454 of this issue.

The second, shown below, is a superheterodyne receiver employing 7 tubes, which is specifically made for use in airports as a "ground" receiver. This set operates from the A.C. line. Both receivers have two wave ranges, covering the regular broadcast band of 550 to 1,700 kc. and also a shorter range which includes beacon and meteorological reports.

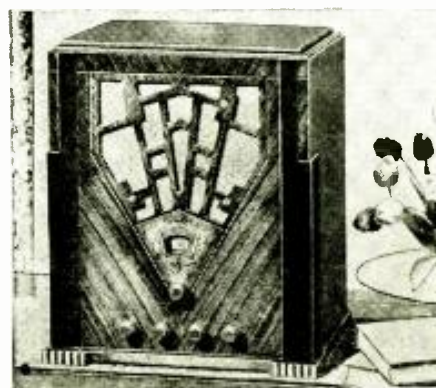

The aviation "ground" receiver (No. 403).

A NOVEL 9 TUBE SET

(Continued from page 475)

builder. The use of a 3-gang condenser having equal capacities for each section is another convenience; condenser C5 in Fig. 1 affords the necessary compensation at the low-frequency end of the tuning scale. An adjustable condenser, C4, permits the receiver to be balanced to individual antenna systems.

For zero-beat code reception, and the heterodyne location of weak phone stations, there is provided a beat oscillator, V8. In order to obtain maximum sensitivity there has been no attempt to include automatic volume control. After all, fading at short wavelengths often is so rapid as to not only outspeed the A.V.C. action but actually to counterphase it sufficiently to produce double the normal time lag! The maximum output of the set, 3 W., is available at the dynamic reproducer supplied with the receiver; a jack is provided for the purpose of connecting external headphones through a coupling condenser, C10 (thus, ultra-sensitive, high permeability core headphones may be used without D.C. flowing through them—nice, eh?). Short-wave "hounds" know the value of a tone control in reducing static effects, and in assisting to separate adjacent-channel code stations; this item has been included in the design.

The volume control, which varies the control-grid bias applied to the I.F. amplifiers, is increased in effectiveness by means of R1 which connects to the maximum "B" supply. Without R1, the drop across R2 would only be about 20 V., but the additional current drain through R2 when R1 is connected, increases the drop to about 50 V. To prevent overloading the tubes, condensers, and reproducer due to voltage surges when changing coils, there is provided a switch which opens the plate supply circuit. The locations of the tubes and the arrangement of the coil connectors are shown in Fig. B. The locations of the remaining components are shown in Fig. C.

Since the single tuning dial is designed for S.L.F. tuning, the instrument is direct reading by reference to the frequency limits engraved on each coil drawer.

Now that the radio constructor knows "what it's all about" he should find no difficulty in picking up the work from this point and completing the job by wiring the assembled chassis in accordance with Fig. 1. The author will be very glad to assist constructors with the completed all-wave receiver.

List of Parts

One 3-gang variable condenser, 140 mmf.;
 One antenna aligning condenser, 10 mmf.;
 One Postal 5 coil inductance kit, complete with aligning and padding condensers;
 Three mica condensers, 100 mmf.;
 Eleven bypass condensers, 0.1-mf.;
 Five mica condensers, .001-mf.;
 Two coupling condensers, 0.6-mmf.;
 Two condensers, 0.5-mf.;
 One 8 mf. electrolytic condenser;
 One single-circuit jack with S.P.D.T. switch;
 One Postal kit of 3 I.F. transformers;
 One Postal beat-oscillator inductance;
 Five R.F. chokes, 8 mhy.;
 One resistor, 350 ohms, 1 W.;
 One resistor, 15,000 ohms, 1 W.;
 Three resistors, 60,000 ohms, 1 W.;
 Three resistors, 25,000 ohms, 1 W.;
 One resistor, 200 ohms, 1 W.;
 One resistor, 50,000 ohms, 1 W.;
 One resistor, 0.1-meg., 1 W.;
 Two resistors, .25-meg., 1 W.;
 One potentiometer, 12,000 ohms;
 One potentiometer, 75,000 ohms;
 One resistor, 1000 ohms, 10 W.;
 One resistor, 27,440 ohms, 25 W.;
 Three S.P.S.T. switches: 1 power, 1 rotor, 1 toggle;
 One power transformer, PT;
 Ten wafer sockets: one 4 prong, one 5-prong, eight 6-prong.
 One illuminated vernier dial;
 One drilled chassis, 11 x 19 x 3 ins. high;
 One drilled black crystalline-finish steel front panel, 19½ x 29¼ x 1/16-in. thick;
 One steel cabinet to fit;
 Nine tubes: 2 57's, 5 58's, 1 2A5, 1 80;
 One dynamic reproducer.



"SUPREME" Precision Testing for Automobile Radios



A vast new market for your radio skill has been born overnight. Sets are being installed in cars by the millions—are to be standard equipment on many 1934 models.

You can't service these radios with obsolete equipment—equipment unprepared for this type of radio set. And neither your service fees nor the demand on your time justify the tedium of dismantling the car to make the old point to point testers get by on these jobs.

You need the precision testing for automobile radio sets built in Supreme Instruments. Supreme equipment eliminates the necessity of removing the set to service it—brings the radio to the panel of the instrument for point to point testing. If you can remove a tube, you can make the complete analysis! That's the advantage of the analysis with the exclusive SUPREME FREE REFERENCE POINT SYSTEM OF ANALYSIS.

Most servicemen know that the plate current of a tube is the result of practically all the circuits leading to the tube and that a normal plate current value would indicate that these circuits are performing their normal functions. It is a simple matter with a Supreme Analyzer to quickly value the plate current of each tube socket until a tube socket is encountered where the plate current is not correct. Then point to point tests can be taken of other circuits to isolate the circuit at fault—right on the panel.

Supreme Testing Equipment gives you "Everything" for servicing the most modern of radio sets, with skill and speed. Plus an acknowledged reputation for minimum obsolescence. A satisfaction of investment that grows with use! Ask your jobber for a demonstration, and send for the complete information contained in our free 1934 catalog.



MODEL 91
SUPREME ANALYZER

SUPREME INSTRUMENTS CORPORATION
483 SUPREME BLDG. GREENWOOD, MISS.

Get Your Copies of the SHURE TECHNICAL BULLETIN

The following back issues of the SHURE TECHNICAL BULLETIN are available now at

6^c per copy.

- No. 1** Condenser vs. Two-Button Microphones.
- No. 2** Field Problems in Microphone Placement. Part 1—Broadcasting.
- No. 3** Field Problems in Microphone Placement. Part 2—Public Address Systems.
- No. 4** Mixing Circuit Design Data.
- No. 5** The Microphone—An Electric Ear. Noise Measurements—Binaural Transmission.
- No. 6** Field Problems in Microphone Placement. Part 3—Multiple Microphone Systems.
- No. 7** Electro-acoustic Measurements of Microphone Performance.

The SHURE TECHNICAL BULLETIN . . . a monthly publication of the Shure Brothers Company, 215 W. Huron St., Chicago, microphone makers . . . contains AUTHORITY AND USEFUL INFORMATION on microphones, microphone placement, design data on associated speech-input circuits, new applications of microphones for industrial and research purposes, and similar technical phases of broadcast and sound engineering.

Copies of the SHURE TECHNICAL BULLETIN may be had without charge by broadcasting, public-address and recording engineers simply by sending in your request on your company's letterhead.

Subscriptions accepted from amateurs, radio service men, and others at the nominal fee of 50c per year.

To be sure of having these valuable issues send for them now. Use the coupon below.

SHURE BROTHERS COMPANY
215 W. Huron Street, Chicago, Ill.

Please send me postpaid the following back issues of the SHURE TECHNICAL BULLETIN:

<input type="checkbox"/> No. 1	<input type="checkbox"/> No. 4
<input type="checkbox"/> No. 2	<input type="checkbox"/> No. 5
<input type="checkbox"/> No. 3	<input type="checkbox"/> No. 6
<input type="checkbox"/> No. 7	

I am enclosing _____ c
(in stamps) (in cash).

Please enter my subscription for one year. I am enclosing 50c in stamps in cash in money order.

Name _____

Address _____

City and State _____

RC-234

RECORDING THE SOUNDS OF BIRDS

(Continued from page 463)

being attached to the bottom of the U. The reflector was suspended on the U mounting by means of the pins set in its pipe ring rim. Those threaded pin fittings were equipped with large wing nuts to maintain the vertical tilting of the reflector at any desired angle. The arrangement is such that the horizontal turning of the reflector is effected by means of the tripod.

Focusing the Reflector

"The exact focus of the sound reflector was obtained by placing an electric light bulb approximately 11 ins. from the center. One person stood 20 ft. in front of the reflector, watching the illumination from the bulb, while another moved the bulb. When the bulb was in such position that the entire surface of the reflector appeared illuminated brightly to the observer who stood some distance away, the bulb was at the focal point of the reflector. That position was marked and a small pipe collar large enough to support the microphone was mounted, in order to hold the mike at the accurate focal point of the reflector.

"A simple gun sight was attached to the reflector to aid in pointing the reflector at the source of sound to be recorded. A modulation meter is used as the final check to make sure that the reflector is pointed correctly before the shutter of the sound-recording camera is opened. When the modulation meter kicks over to the maximum of its path, the reflector is pointed correctly. The use of this efficient homespun sound reflector, enables the bird song recorders to work at a lower gain level because the reflector amplifies the sound mechanically. Also, when working with such a reflector, one can more or less control the direction of recording, so that extraneous sound may be eliminated."

Some birds such as the song sparrows are complete failures as radio singers because their notes and calls are so high-keyed and shrill that they do not reproduce satisfactorily from the sound track of talkie film. Others such as the bluebird, robin and wood thrush are stars of the bird talkies in the same degree that they are the cherished singers of our American woodlands and open country. The sound camera-men have to exercise care in making the bird talkies, that the mimicry of the talented mocking bird does not ruin some of the film. That bird's power of imitation is so well developed that some of his apeing may be recorded as the supposedly genuine notes of the birds he is simulating, unless the recorders are on the watch.

A large amount of film was also ruined by extraneous sounds and noises, such as the drone of a remote airplane engine, the whirl and rustle of dry leaves and foliage, the wind murmuring amongst the pine trees or the staccato snorts of an overloaded motor truck. Those sounds produced some distance from the perch of the singing bird, whose calls were being preserved in celluloid film, were on various occasions caught up and measurably amplified on the film. When the film was developed and tested for talkie efficiency, the extraneous sounds were as outstanding as the bird notes and in some cases almost drowned out the melodious music of a skilled song-bird.

The Probabilities of Success

Mr. Brand reports that only approximately 7 per cent of the 30,000 feet of sound film which he has exposed has been used for making phonograph records and talkie movies. Considerable footage of the sound film did not come up to standard after development, while other reels were ruined because of the infraction of extraneous sounds.

Fifty of the most satisfactory bird songs recorded on the sound track of the celluloid film are being transferred to phonograph records, while the sound records of 27 avian opera singers are being combined with motion pictures to make complete bird talkies and movies.

This bird song hunter, who travels in a special truck and uses a sound camera in lieu of firearms, told me that usually he is satisfied if he obtains satisfactory records of

one or two birds a morning. It is rare for him to experience the good luck of being able to make 3 bird music records in a single morning. His masterpiece is an exceptionally fine morning's work when he recorded the voices of 5 birds in a few hours. He has discovered by experience that different bird voices vary decidedly in carrying power. Mr. Brand has made some excellent sound records as far as 500 or 600 ft. from the bird singer or about 300 ft. from the microphone.

During the 1933 "recording season," from early spring until late summer, Mr. Brand has made but one important change in his equipment. It consists in the supplementary provision of an extra pair of headphones and a cable which can be extended to any desired point of set-up, with the microphone and the parabolic reflector. This arrangement enables the person who operates the reflector to listen in and determine accurately at what position the song bird is at proper focus with the parabola.

There is no evidence available from these bird voice records that different species of our feathered friends communicate with each other by means of their music. Apparently, the majority of the birds understand the signals of danger and warning used by both their relatives and rivals. Each bird race has distinctive calls, some for advising the young that the mother has found food, others summoning the fledglings back to the nest after their primary lessons in flight. There are vital differences in the pitch, quality and timber of various bird songs and calls. The expert birdman can distinguish and identify the different birds without actually seeing the songsters by merely listening for such voice peculiarities. Birds of the same variety that live in different sections of the United States vary slightly in their typical songs, notes and calls. Among some of the fascinating song birds whose musical repertoires are being catalogued in library form as a result of Mr. Brand's invaluable experiments are the hermit thrush, scarlet tanager, veery, wood thrush, house wren, black-capped chickadee, northern flicker, whip-poor-will, white-breasted nuthatch, olive-backed thrush, alder flycatcher, yellow-throated vireo, magnolia warbler, bob-o-link, red-winged blackbird, northern water thrush, Canadian warbler, eastern meadow-lark, field sparrow, chipping sparrow, red-eyed vireo and many others.

110 V. D.C. TUBE CHECKER

(Continued from page 477)

Circuit details are given of designs to be used as a separate attachment to a milliammeter in other equipment; and of an all-in-one tube checker.

Details of the A.C. tube section of the checker are not given as they have been covered in many published articles in recent months.

The voltmeter normally has the high range in the circuit to prevent burnouts when the checker is plugged into a line, with no tube in the socket. The switch button is depressed to read the low range.

The operation is simple. For instance, a 48 tube is placed in its correct socket and the voltage adjusted by means of the rheostat to 50 V. (the correct filament voltage for this tube). If no short is indicated by the pilot light, the switch is thrown to the regular position and a reading taken on the milliammeter. The bias button is then pressed to take a comparative reading.

Exact calibration, and constructional details are left to the individual builder.

List of Parts

- One 4 prong socket;
- Two 5 prong sockets;
- Two 6 prong sockets;
- One 500 ohm, 75 W. resistor;
- One 1,500 ohm resistor;
- One 200 ohm resistor;
- One 200 ohm resistor;
- Three S.P.D.T. switches;
- One voltmeter, A.C. and D.C. type;
- Two binding posts;
- One pilot light and socket;
- One grid cap;
- Wire, panel, mounting brackets, power cord, plug, etc., as needed.

THE BEGINNER'S I-TUBE S.W. SET

(Continued from page 467)

as shown very clearly in the diagram, Fig. 1 and the photographs, Figs. A and B. Then you are ready to wire the set.

Wiring

In wiring, the main point is to be sure of a good, properly soldered joint. (May we remark, "positively,"—*Technical Editor*—Soldering is quite an art, though its requirements are simple. A clean, well-tinned iron and clean surfaces are all the requisites, if the iron is hot. By a hot iron is meant one which causes the solder to flow freely in and through the joint; not one that simply causes the solder to assume a pasty consistency. The proper method to follow in soldering a joint is as follows: first, clean the parts to be joined by scraping them bright; second, make a good mechanical joint (by twisting the parts together, if possible); third, heat the parts with the tip of the iron until solder applied to the parts (not the iron) melts and runs freely. Always use resin core solder, never any kind of acid core, paste or liquid flux of any description.

Referring to Figs. 1 and 2, there may be some question regarding the socket connections of V1. Looking down on the top of the socket, the lone connection is the control-grid, or No. 1 contact in the view and diagram. Continuing clockwise (left to right) around a circle, the connections are, successively, No. 2, plate; No. 3, filament; No. 4, filament; No. 5, screen-grid.

Operation

After everything is wired place the tube in the socket, connect the "A," and the negative side of the "B" battery, connect the phones to their clips, and plug in one of the coils.

The filament should show a dull red glow. Now flip the positive "B" wire across its post; if a loud, sharp click is heard in the phones, connect the wire permanently. Connect the antenna and ground wires.

Now, put the phones on your head and turn the screw on the antenna trimming condenser, C2, all the way open; turn the tuning control until the plates of C1 are completely meshed; and adjust potentiometer R2 until all the resistance is out of the circuit—which should be all the way to the right if it is wired in correctly. Touching the stator (fixed plates) of C1 should result in a decided "thump" in the phones, showing that the circuit is oscillating. As the oscillation control, R2, is turned away from the maximum position this thump will become weaker and weaker, and finally disappear altogether if the entire circuit is in proper adjustment.

Now turn R2 back to maximum and rotate the tuning condenser, C1, slowly to its minimum position, meanwhile touching the finger at intervals to the stator. The thump should be present all the way across the dial.

Repeat the entire sequence given above with each of the coils in turn. If they all oscillate satisfactorily you are ready to adjust the antenna trimmer and start hunting for stations.

Adjusting this trimmer may prove to be a rather tedious process since it is, theoretically, different for each coil. Practically, however, a position is usually found which works fairly well on all coils. To find this position proceed as follows: starting with the broadcast coil in place, check for oscillation as before but on each trip across the dial screw down condenser C2 a little further. A position will finally be found where oscillation stops on certain parts of the band. At this point adjust the screw just a little, until oscillation occurs all across the dial. Then plug in the next smaller coil and repeat the procedure; and so on for all of them. The antenna and ground must be in place for this operation.

Tuning

With any given set there are three main factors which contribute more than anything else to short-wave success: (1) the location; (2) the antenna; and, (3) the tuning procedure. The first, of course, you can't do much about; but the others are within your control.

Servicemen

LOOK AT THIS

"A" BATTERY PERFORMANCE CURVE

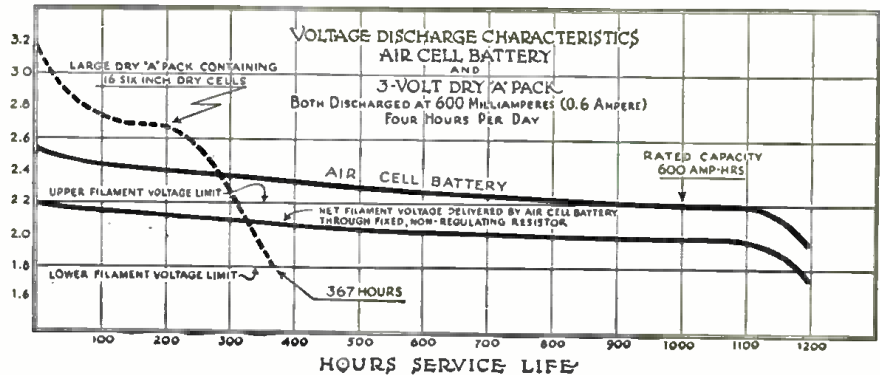

This curve shows why you can stake your reputation on the Air Cell Receiver

The unique, flat discharge curve of the Eveready Air Cell "A" Battery insures ideal filament voltage at all times. It cannot be high enough to cause tube burnout — or low enough to permit weak reception.



No rheostat or control of any kind is needed.

SEND IN THIS COUPON...

for full technical information about the new and improved Eveready Air Cell "A" Battery.

National Carbon Company, Inc.
30 East 42nd Street, Dept. RC-2, New York, N. Y.

Please send me free copy of your new booklet, "The New and Improved Eveready Air Cell "A" Battery".



"Who's Afraid OF THE BIG BAD WOLF."

The "huffs" and "puffs" of vibration, excessive heat and overloads mean nothing to a Centralab resistor, safely housed in its protective ceramic cover (an integral part of the resistor itself). No wonder CENTRALAB Resistors defy abuses that would make the average resistor fail to function.

Your jobber has the new 1934 Volume Control Guide. Ask for it!

Centralab
CENTRAL RADIO LABORATORIES
MILWAUKEE WISCONSIN

Try this FORMULA

WHEN you design or build that new Set Analyzer, Decade Box, Bridge, Ohmmeter or High Resistance Voltmeter why not try this FORMULA:

$$Q + A + MD = P \times W \times R$$

When Q equals QUALITY and A equals ACCURACY MD equals MODERN DESIGN and LC equals LOW COST and LAST COST then P W R is always PRECISION WIRE WOUND RESISTORS.
RESISTANCE RANGE: .25 Ohm to 1 Megohm

TYPE "F"
Normal Rating 1 Watt
Maximum Length 1" Maximum Diameter 3/4" Length of Leads 1 1/2" Furnished with No. 18 Tinned Copper Leads.



TYPE "D"
Normal Rating 1/2 Watt
Maximum Length 3/4" Maximum Diameter 3/8" Length of Leads 3/4" Furnished with No. 18 Tinned Copper Leads.

Free Booklets and Price List
Precision Custom Built Wire Wound Resistors, Mfg. by
PRECISION RESISTOR CO.
334 Badger Ave. Newark, N. J.

JUST OFF THE PRESS!
Free MAKE US YOUR HEADQUARTERS FOR PUBLIC ADDRESS AMPLIFIERS
Deal DIRECT with Manufacturers and SAVE BIG MONEY.
1934 RADIO AND AMPLIFIER CATALOG
COAST TO COAST RADIO CORP.
121-32 WEST 17th ST., NEW YORK, N. Y.

A word regarding the antenna system may not be amiss here, since the builder of this set is supposed to be an absolute beginner. For best short-wave results the antenna should be as high as possible and strung clear of everything else; particularly, it should be kept away from trees and be well insulated. Two 2 or 3 in., high-grade insulators at each end will give excellent results. The best all around wire for antenna purposes is No. 14 solid enamel, about 50 ft. long. The aerial should be pulled taut so that it cannot swing in the wind and thus cause fading. Springs are sold to be placed at the end of aerials for this purpose and their use is advisable.

The lead-in can be made of No. 11 rubber-covered wire securely soldered to the aerial at one end; form a loop so as to allow the aerial to move slightly without eventually causing a break at this joint. Stand-off insulators, holding the wire several inches from the building, should be used at intervals along the length of the lead-in. A lightning arrestor on the outside of the building and going to an outside ground is advisable, particularly in rural regions. The lead-in is carried into the house through a porcelain tube which is mounted in the window frame. Slant the tube upward so that it will shed water. Don't under any circumstances, use one of those flat contraptions that is supposed to go under the window.

Inside the house, the set should be grounded with a wire, as short as possible, to the cold water piping. If convenient, this connection should be made on the street side of the water-meter as they sometimes have fiber bushings in them which break the electrical continuity of the pipe. If this is so in your case and you cannot conveniently run the line direct, at least "jump" the meter with a wire securely fastened to each side.

In country districts without piped water an excellent ground can be made to the pump frame, or to one or more pipes driven 5 to 10 ft. into the ground. This may all seem very elaborate, but remember that the finest set made will operate better on an antenna system as described and it will surely operate our little set better. Furthermore, every point noted is important even on broadcast sets and becomes more and more so as the frequency is increased (wavelength reduced).

In locations particularly "tough" for reception it may be necessary to experiment with the direction of the aerial as this sometimes makes an appreciable difference.

The other point within our control, that of tuning, is primarily a question of patience. The most sensitive point for any regenerative receiver is just at the point of circuit oscillation. Turning the tuning dial and oscillation control together, meanwhile checking for the presence of oscillation by the method explained before will give you an approximate idea of just how the two line-up on any given coil. The procedure is to keep the set adjusted just inside the oscillation point and to turn the tuning dial *very slowly* until you hear a whistle; then, tune for the silent point between two whistles and "juggle" the oscillation control until you bring in the station. For broadcast and phone stations, this will be just outside the oscillation point; and for code stations, just inside. The main points to remember are: *slow tuning*; and, *careful adjustment of the oscillation control*.

Trouble Shooting

The set is so simple in design that trouble is not likely to occur; the foremost possibility, however, is lack of circuit oscillation. If the circuit will not oscillate, the first thing to do is to reverse the connections to P and F on the coil socket. The grid leak, R1, is also a factor in producing oscillation. Values from 1 to 10 megs. may be tried in this position. It may be necessary, particularly in the smallest coil, to add a turn or two to the tickler (the coil between the P and F socket terminals). Since the tube must be a good one—a poor tube will not oscillate—before going into the business of adding turns it might be well to try another tube.

And while on the subject of tubes, heed the warning that the 2 V. series of tubes are very delicate and must be handled with extreme care. They will not stand an over-

load on the filaments—if this occurs, either from too much plate current or too much filament voltage, the emission from the filament is destroyed and the tube is rendered useless. In this particular circuit do not put more than 67 1/2 V. of "B" battery in use (less, if possible).

Coil Data

It is advised that the beginner purchase a set of coils already wound, but if desired he may wind coils to the data given in Fig. 3. The coils are all wound on standard short-wave plug-in forms 1 1/4 ins. diameter x 2 3/8 ins. long, four prong. The tuned winding is connected between the grid prong and one filament prong and the tickler between the plate and the other filament.

The specifications given in Fig. 3 for the broadcast coil simply mean that the wire is to be wound solid (one turn against the next) for the distances given. This is easier than counting turns when there are as many as in this case.

Be sure to wind all coils the same way (in the same direction) and connect the same ends to the same prong. Otherwise, some coils will oscillate and others will not.

Come on in, fellows, the short waves are fine!

List of Parts

- One Hammarlund Star tuning condenser, 140 mmf., C1;
- One Hammarlund 5 to 70 mmf. balancing condenser, C2;
- One 350 mmf. mica grid condenser, C3;
- One .002-mf. mica condenser, C4;
- One .1-mf. non-inductive paper condenser, 200 V., C5;
- One 2 meg. grid leak, R1;
- One 50,000 ohm wire-wound potentiometer, R2;
- One 4-prong socket for coils L1-L2;
- One 5-prong spring mounted socket for the tube;
- Four spring binding posts;
- One wood baseboard, 8 1/4 x 9 x 3/8-in.;
- One aluminum panel, 8 1/4 x 6 x 1/16-in.;
- One type 33 tube, V1;
- One pair of sensitive headphones;
- One roll of push-back hook-up wire;
- Three 22 1/2 V. small "B" batteries;
- One 2 V. storage cell;
- Small screws;
- Four Fahnestock clips;
- One vernier dial.

READERS' PAGE

(Continued from page 473)

At this, a prolonged discussion began as to whether or not it is to the Service Man's advantage to follow A's or B's method.

I know that, personally, (when employed as a dealer's Service Man) I have replaced parts that I've known by previous experience would not stand the gaff, although at the moment of inspection they were O.K. (This was done to cut down repeat calls and to keep that particular set sold).

I had a chart of about 35 standard receivers in which such replacements were advisable, and price costs for those parts for ready reference.

Such a chart or data would be of vital interest to Service Men, and service managers. More so, than descriptions of freak troubles which may or may not develop again in a hundred or so others of the same model.

Would you be interested in a series of articles of this kind, articles listing only those troubles, which experience has shown to be almost invariably present in certain models?

The pertinent questions that arise in this article are:

Should the independent Service Men follow B's method of procedure? Would it be to his profit? Should Service Men mention other faults to the customer of that particular model? What would the manufacturer's attitude be toward the Service Man if he follows this procedure?

What do you think?

A. H. DOBRAN,
c/o Brown Radio Service,
882 Southern Boulevard
Bronx, N. Y.

(We think your idea is a splendid one. Mr. Dobran, However, the compilation of such "super" service notes would be real hard work for the technician who underrook the task of preparing them, for any number of popular receivers. If you feel ambitious enough to make the first attempts—more power to you, and we will be "Johnny on the spot" when the time comes to publish them.

Regarding your question of the attitude of manufacturers toward "B's" method of repair, there is no doubt but some of them would object. But this should not be serious, especially since you would be helping to keep their sets "sold," as you so aptly word it.—Editor)

SOME "TRICK" REVISIONS FOR THE "PENTODE PORTABLE"

Editor, RADIO-CRAFT:

I have made some drastic changes in my "A.C. Pentode Portable" as described in the September, 1931 issue of RADIO-CRAFT. Whether or not they are according to "Hoyle" or the rest of the wizards, I don't know. Suffice to say the changes improved the set considerably.

First I changed the tuned circuit putting in another coil in place of the one I was using; it is of the plug-in variety, tube base size and about 3 ins. long. It was composed of primary and secondary windings, wound over the grid end of the secondary. I wound about 13 turns of No. 24 D.C.C. wire to be used as one primary, the other primary to be used as a tickler.

Next, I changed the type 27 detector to a 58 with a 10,000 ohm regeneration control across the tickler winding.

Everything went fine till I spied a 58 which I proceeded to use as an untuned R.F. amplifier. I put a 10,000 ohm resistor from grid to grid of this R.F. stage; I should have used a higher value of resistance but did not have it. As to the plate circuit, well, it is patched up. I knew I had to use a high impedance, so I found an old Remler I.F. transformer from which I took one primary winding and put it between the plate of the 58 and "B"; then coupled the plate to primary of the detector circuit through a .001-mf. condenser. (I know the capacity is wrong, but when you experiment you do not always have the proper parts to use.) I tied the "superheterodyne" grid to the cathode and the "B" end of the plate impedance to the screen-grid; it is probably "phony" but it works; and pretty good at that.

As to the A.F. tube I am now using a 27 with considerably increased volume.

Then the rectifier—it seemed as if I must do something with that, so I tried a 24A tube with the screen-grid, control-grid and plate tied together. After that I noticed less hum and some increase in volume.

The R.F. stage almost doubled volume and the 27 helped the tone.

I bought a midsize magnetic speaker (5 ins.) with 1,200 ohms resistance, so with all the set "perks" fine. Although regenerative, the set does not radiate oscillations. With only a 25 ft. speaker extension cord as aerial, it will pick up all the locals and stations within a 500 mile range with speaker volume, thanks to the 58.

As to tube voltages, I know nothing about them, as I have no test equipment. I have to depend on the cut-and-try method which is a disheartening procedure and consumes some time, but it is a good teacher. For technical "info," I depend on RADIO-CRAFT which seldom disappoints me.

Why this or that works I don't know but I sure have a swell time trying them.

This set is sensitive and selective with very little station overlapping even on strong locals.

Please remember the fundamental circuit is not mine but is due to an article in the September, 1931 issue of RADIO-CRAFT. The rectifier circuit I copied from one in POPULAR MECHANICS.

I'll probably make more changes, particularly in the A.F. end.

JOS. H. MILLER,
1012 Lenore Ave.,
Columbus, Ohio.

A NEW MODE IN MUSIC

Plus

Consistent

WORLD WIDE RECEPTION

15-550 Meters

HIGH SENSITIVITY
LOW NOISE LEVEL
SELECTIVITY

REVOLUTIONARY
AUDIO SYSTEM

ULTRA SENSITIVE
SIGNAL INDICATOR

BAND SPREAD
ON ALL FREQUENCIES

A.V.C. REGULATION

AUTOMATIC VOLTAGE
CONTROL

12 WATTS UNDISTORTED
OUTPUT TRIODE
QUALITY

CALIBRATED 280°
NON BACK LASH DIAL

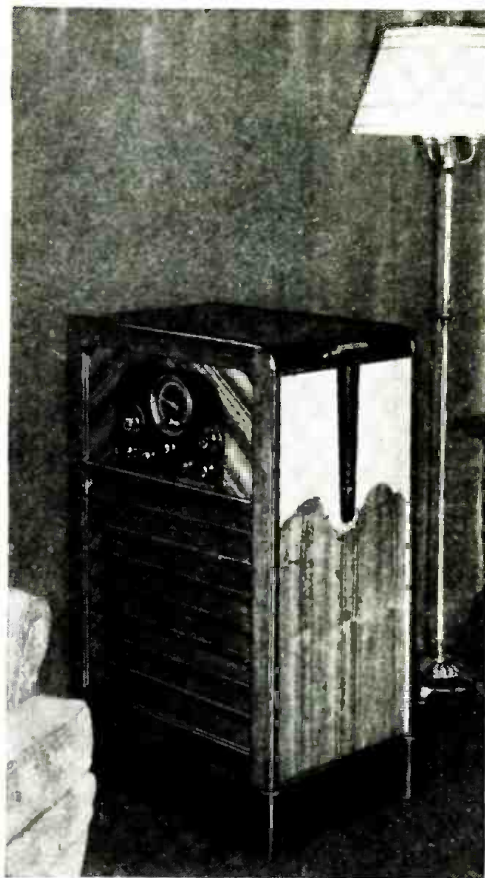

The Baton

MANY OTHER NEW FEATURES IN THE

New Ultra DeLuxe Lincoln

A beautiful new design in modern radio furniture. Full sound waves from the speaker are projected into the room through both sides of the console, creating a perfect diffusion, eliminating the directional beam found in all other radio furniture. Made from beautiful African Walnut with ebony finish trim inlaid with chrome, and birds-eye maple overlays, in piano finish.

Write today for complete information why Elwin Bullard, Drummondville, Que., (a Lincoln owner) won last month's International DX'ers contest with a verification of 11H, 15 watter of San Pedro de Macoris, Dominion Republic. Why, Enrique Cortes, Barcelona, Spain, receives more than fifty stations between 16 and 28 meters; and why Luc Foucard & Co., Port-de-Paix, Haiti, report— "Pontoise, a station which interests us most and from which the signals fade to such a degree that we cannot hear them on other apparatus, is maintained at a volume always constant to such point that we can hear everything with

clarity on the Lincoln. Daily and at any time of the day, Pontoise comes in with the same facility; atmospheric static does not affect the reception of the Lincoln."

WRITE FOR
COMPLETE
DETAILS

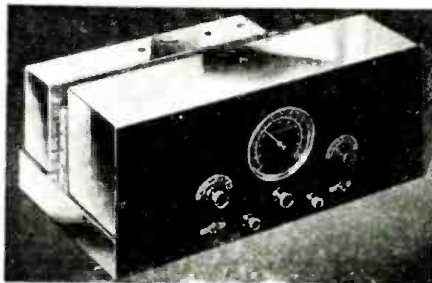

The New Lincoln Chassis

12 TUBE SUPERHETERODYNE

LINCOLN RADIO CORPORATION

2222 Diversey Avenue
CHICAGO, ILL.

NAME _____
STREET _____
CITY _____ STATE _____
2222 Diversey Ave., Chicago, Ill. Dept. R-2

Low Cost PA System



NOW MADE POSSIBLE WITH THIS

2B6 Two-Stage AMPLIFIER

Here is Radio's newest sensation! This compact, efficient and simplified amplifier will operate from 4 to 5 dynamic speakers! Now, for the first time, this 2B6 Amplifier makes it possible to assemble a low cost P.A. System simply by adding a single or double button microphone, suitable matching transformer, 2 dry cells, speakers and phone plug-up.

OUR SPECIAL PRICE
AMPLIFIER ONLY **\$14.95**

Everything in Short-Wave Supplies!

Now you can buy everything from ONE SOURCE from the world's largest stock of replacement parts! Receivers, coils, condensers, converters, crystals, sets by National, Hammarlund, Lafayette, etc. . . . AT LOWEST WHOLESALE PRICES! Get our Big Free Catalog!

Wholesale Radio Service Co., Inc.
100 Sixth Ave., New York
219 CENTRAL AVE., NEWARK, N.J.

- Please send me one 2B6 Amplifier @ \$14.95.
- Send me additional information.
- Please send me your catalog No. 55.

Name

Address

City..... State.....

Dept C-24.

Seeing



is
Believing

Make this Simple Test!

Go to your regular source of supply; take a group of Resistors of different values of any competitive make; take a similar group of LYNCH Resistors; test them all with an accurate ohmmeter.

LYNCH RESISTORS

Speak for Themselves

Free Descriptive Folder Upon Request

LYNCH MANUFACTURING CO., Inc.
51 Vesey Street, New York, N. Y.

Makers of the Lynch Noise-Reducing Antenna Systems

AN INTRODUCTION TO RADIO DYNAMICS

(Continued from page 472)

matter of fact, it is not necessary to follow the details exactly in constructing the control, so long as the basic requirements for the individual instruments are met.

The base is made from an old cake tin measuring 6½ x 11½ x 1 in. deep. A coat of aluminum paint improves its appearance and gives no clue to its former "occupation." It will be noted that six terminals are mounted on the sloping sides of the pan, four in the rear and two at the sides. A slot is cut in the pan so these posts are all insulated by the bakelite strip. This is important and care should be taken that none are grounded. (Fig. 1.)

A standard 4 prong radio socket, single circuit jack, 30 ohm rheostat and switch are also mounted as shown in Figs. A and B.

The Sensitive Relay

Now comes the special equipment. The input transformer that couples the microphone to the tube is made from an old A.F. transformer with a burned out primary, by dismantling and removing the defective primary. A small wooden form is made that will give a coil of approximately the same dimensions as the old primary. This form is wound full of No. 36 to 40 enameled wire (until it has a resistance of about 200 ohms). It is then put in place of the original primary and the transformer reassembled.

Next is the sensitive relay in the plate circuit of the tube. The writer happened to have one available, wound to 1000 ohms. This relay should be very sensitive and unless one is equipped to build precision apparatus it is best to purchase this instrument. A number are available on the market for less than five dollars.

The On-Off Relay

Then comes the on-off relay which performs a very important function and presents the most difficult problem of the entire device. It might be well to describe its function before describing its construction. The use of the other apparatus is fairly obvious, the varying currents produced in the microphone are fed into an amplifying tube by means of the coupling transformer. The amplified current operates the sensitive relay in the plate circuit. But the latter relay will only remain closed while sound is impinging on the microphone and will open when the sound stops. Were this relay controlling, for example, a set of electric trains, they would only operate while sound was striking the microphone. The function of the on-off relay, then, is to close the circuit when the plate relay closes for an instant (when the word "start" is spoken into the microphone) and keep the circuit closed and the trains running until the word "stop" is spoken, when it will open the circuit. This effect is obtained by so arranging a switch lever that a thrust of the relay armature swings it one way and the next thrust swings it back.

The design of such a relay presents an interesting little problem for students of mechanics and the form devised by the writer is but one of the many possible arrangements that might be used. The constructor might well endeavor to devise a simpler form if so inclined.

The relay used is shown in detail in Fig. 2. An old telephone relay was dismantled, in the writer's unit, to form the driving element. A length of heavy piano wire forms an extension for the short armature to increase the length of its throw as shown. A pusher strip is made from a thin strip of brass, ¼-in. wide, with a loop formed in one end to fit loosely around the armature extension piece. The tension spring on the armature is mounted by drilling a clearance hole in the armature and a tap hole in the armature support, for an 8-32 threaded rod. On this rod is assembled a light coil spring which is put under tension by means of a brass battery nut.

The body of the switch arm is cut from bakelite to the shape shown in Fig. 2. The switch blade is riveted to this bakelite piece

which is also drilled for a pivot and a small hole provided for the end of the selector spring to rest in. The pivot for the armature is a brass escutcheon pin that fits snugly into the bakelite strip which forms the base for the relay assembly. Three contact points are provided for the switch blade to travel over. The selector spring is a length of fine piano wire bent into a loop with one end soldered to the thrust strip.

The final assembly of this relay is by the trial-and-error system. Assemble the device, not neglecting the soldering lugs under the contact points and make sure the blade travels smoothly over the contacts. The soldering lugs under the outer contacts are then bent over as shown to form a clip into which the switch blade easily slides. With the selector spring in place, the operation of the relay can be tested by pressing the armature down with the finger. With the blade to one side, the first "press" should swing the blade over, releasing the armature allows the thrust strip to come back and the selector spring swings the strip over so that the strip is in line with the notch on the other side of the pivot and a second depression of the armature swings the switch arm back. It will take a little experimenting to get the relay working just right. It may be necessary to file the notches slightly to let the strip swing over. Bend the armature extension a bit so it throws the switch arm all the way over or adjust the clips on the contacts so the switch arm will not spring out of them but will pull out easily when the relay acts. A drop of oil on the moving parts will often help.

The Power Relay

The final piece of apparatus is the heavy relay. Although the on-off relay will control lights and signal devices without this extra relay it is well to use it in the device to preclude any danger of burning the contacts on the on-off relay and deranging its operation. The heavy relay is simply a battery charging relay from an automobile generator with the heavy winding removed. One end of the remaining voltage winding is grounded, so the relay frame must be insulated from the base. The tension on the relay is decreased somewhat, by bending the tension spring stop. This relay will handle heavy currents without arcing.

The final assembly and wiring can be done according to the diagram in Fig. 1. It would be well to solder all joints to prevent trouble from loose connections that too often occur with screwed terminals. Where it is necessary to pass wire through the metal base, a hole punched with an ice pick is the most suitable, for it leaves a rounded edge to the hole that does less damage to insulated wire than a drilled hole.

Testing and Adjusting the Unit

When connections are complete, the apparatus can be connected to the batteries. The writer used the dry-cell type of tube with a 2 V. filament. Other tubes may be used if desired. In the case of 01A tubes, the negative 6 and negative 3 are wired together and connected to the negative terminal of a storage battery. Practically any tube that can be operated by batteries may be used with no important changes other than to see the proper filament voltage is applied and that 6 V. is applied between terminals "A—" 6 V. and "A+B—" in Fig. 1.

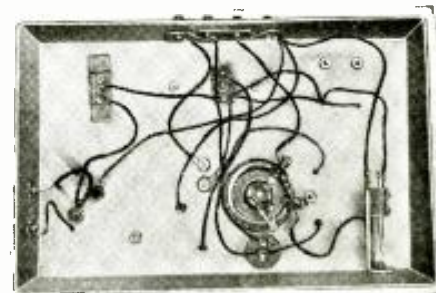

Fig. B
The under view of the "pie-pan" chassis.

After connecting the batteries, the operation of the relays is tested before inserting the tube. Close the sensitive relay with the finger and note if the on-off relay throws each time contact is made, the heavy relay closing when the on-off relay swings one way and opening when it swings back. If this action does not take place, check the circuit again and look for trouble in the relays. They must work before attempting to use voice control.

After checking relays, connect a telephone transmitter into the jack and insert the tube in the socket. Bring the filament of the tube up to proper brilliancy and adjust the sensitive relay while tapping the transmitter diaphragm with the finger nail. This adjustment will be found rather critical and will be simplified if a milliammeter is connected into the plate circuit of the tube, which will indicate the plate current change when the transmitter is tapped. Usually the plate current will read 4 ma. and jump to 6 or 8 ma. when the transmitter is tapped. It is this swing that actuates the sensitive relay which requires close adjustment of the contacts and proper setting of the tension spring. With a little care, it is not difficult to obtain a setting where, on speaking one word distinctly into the transmitter, the relays all click. This completes the "control."

It is now ready to actuate any electrical device desired. As previously mentioned, it is very effective with toy trains, the two terminals on the side of the control device being connected across the switch regularly used for switching on the trains.

The work of building and adjusting such a device is well repaid when it is working. It opens up many interesting avenues of speculation and permits a host of puzzling experiments. The writer has succeeded in turning lights on and off in a room by clapping his hands, switching a radio set on and off, and lighting the garage with a blast of the horn. When the apparatus is to be used for such purposes even temporarily it would be well to mount the batteries and control device in a box to make it easily portable.

List of Parts

One base made from a cake tin, 11½ x 6½ x 1 in. high;
 One single-pole toggle switch;
 One 4 prong bakelite socket;
 One 30 ohm rheostat;
 One A.F. transformer, remodeled into input transformer by rewinding primary to 200 ohms using No. 36 to 40 wire;
 One sensitive relay, 1000 ohms;
 One 6 V. automobile cutout relay (model T Ford) series winding removed;
 One telephone relay, 20 ohms resistance (remodeled into a step-by-step relay);
 Six binding posts;
 One single circuit jack;
 One telephone transmitter or microphone;
 One cord and plug for microphone;
 One type 01A tube, V1.

(The subject of radio dynamics is one that is of interest to every "dyed in the wool" radio experimenter. We are on the look-out for other interesting articles on this and allied subjects and will pay space rates upon publication, for all material printed. So get your thinking caps on, fellows—reap some profit from your hobby!—Associate Editor)

MAKING A HOME-RECORDING CONTROL

(Continued from page 474)

is opened when the control switch is set for "recording." This is done in order to prevent an A.F. feedback or howl from starting when making a record. The wires leading from the voice-coil circuit to the control switch should be run through braided shielding, and the shield grounded. The same holds true for the wires running from the microphone to the microphone-control box.

The experimenter or custom set builder who builds this unit, will find that it is both flexible and easy to operate. It is a useful addition to any phono-radio combination.

ONE INSTRUMENT FOR ALL MEASUREMENTS Resistance-Current-Voltage

.. THE NX

UNIVERSAL RECTOX

THIS Westinghouse panel-mounting instrument was specially developed for the radio service man, the experimenter and the amateur.

The self-contained instrument covers the following ranges.

Milliamps., d-c.	0-1
Milliamps., a-c.	0-1
Millivolts, d-c.	0-100
Volts, a-c.	0-5

For additional ranges, we can supply resistances for voltage measurements, combination shunts for current measurements, and resistors for resistance measurements. These accessories give the following ranges:

Volts, d-c.	0-1-5-10-50-100-200-500-1000
Volts, a-c.	0-10-50-100-200-500-1000
Milliamps., d-c.	0-5-10-50-100-500
Milliamps., a-c.	0-5-10-50-100
Amperes, d-c.	0-1-5-10-50
Ohms	0-1000-10,000-100,000

Westinghouse

Since 1888, manufacturers of highest quality instruments, which are now available at standard prices. There is no longer any reason for accepting lower standards.

Territory is still open for dealers.



With these ranges, practically any measurement of voltage, current or resistance can be made for checking receiving-set operation; for test bench work; for laboratory experiments; or for the adjustment and operation of transmitting sets. The instrument with its complete set of accessories mounted on a panel or in a box, with the necessary switches, makes an ideal test set.

Catalog 43-341 describes the construction features that result in the high quality of the NX Universal Rectox Instrument, lists the instrument and all accessories, and includes connection diagrams. Send the coupon or a post card for your copy.

SEND FOR CATALOG

Westinghouse Electric & Mfg. Company
 Dept. 116, Room 2-N—East Pittsburgh, Pa.

Please send free copy of Catalog 43-341 containing complete description of the Universal Rectox Instrument.

Name

Address T 79843

City.....State..... RC 2-34

NEW COIL SELECTOR

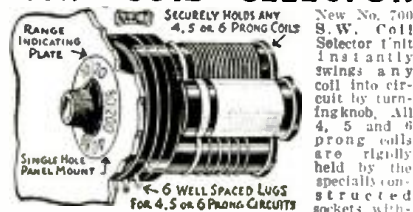

SECURELY HOLDS ANY 4, 5 OR 6 PRONG COILS
 New No. 700 S.W. Coil Selector Unit instantly swings any coil into circuit by turning knob. All 4, 5 and 6 prong coils are rigidly held by the specially constructed sockets without adjustment.
 Range indicating plate.
 Single hole panel mount.
 6 well spaced lugs for 4, 5 or 6 prong circuits.
 Moments of any kind. Knob and indicator on face of panel show which coil is in circuit. Simple—compact—rugged—electrically efficient. Don't fail to use it in sets you are building and new equipment you are designing.
 No. 700 COIL SELECTOR UNIT without coils. List Price \$3.50
NA-ALD ALDEN PRODUCTS CO
 Dept. R-2 715 Center St
 BROCKTON MASS



.. BUD LOUD SPEAKERS

5 DAYS FREE Trial
 NORMAL efficiency ¼ to 2½ watts
 —peak capacity 50 watts! BUD'S new diaphragm and voice coil assembly assure higher efficiency and far greater dependability! Write for literature on 14 1/2 units, all aluminum, weatherproof "NATURAL-TONE" trumpets, microphones, etc., air column horns.
 Get details of Five-Day Free Trial and information on our new high frequency theatre unit.

BUD SPEAKER CO.
 1109 JACKSON AVENUE
 TOLEDO, OHIO—U.S.A.

NEVER OBSOLETE

Shallcross Number 611 Universal Tester

will be as modern next
year as it is today



TESTS
any radio re-
ceiver electri-
cal circuit
CONDENSERS
paper or
electrolytic
RESISTORS
fixed or
variable
Transformers
Chokes

It is now possible for the radio service technician to carry only one test instrument, the SHALLCROSS No. 611 Universal Tester. It will always be up to date, no matter what new tubes may be introduced into the industry.

Send 3c in stamps for Bulletin No. 611-P describing this instrument.

SHALLCROSS MFG. COMPANY
Electrical Measuring Instruments
and Accurate Resistors
700 MAC DADD BOULEVARD
COLLINGDALE, PA.

To Tune The "5-Meter Transceiver" and "Beginners' S-W Receiver"

A CONDENSER is just a condenser to careless set builders. But if best results are desired it is wise to use the condensers specified by the circuit designer.

When he names HAMMARLUND CONDENSERS for the "5-Meter Transceiver" and "Beginners' S-W Receiver," featured in Radio-Craft, it is smart to be safe and not gamble with substitutes. Write Dept. RC-2 for the New Hammarlund Catalog "34" of Precision Parts.

HAMMARLUND MFG. CO.
424 West 33rd Street New York



SERVICING THE "TALKIES"

(Continued from page 477)

The Illusion of Motion

The illusion of moving pictures is created by projecting a large number of images in rapid succession (in practice, sixteen per second) with dark intervals between. The dark interludes are not visible because such projection is more rapid than human sight. An optical illusion called *persistence of vision* prevents the eye from perceiving them. If all the pictures are precisely alike—which happens when the characters on the screen remain perfectly motionless—the eye sees one unchanging and continuous picture. When these pictures are not identical, but each differs slightly from the others, the illusion of motion results. For example, a baseball is thrown; the first picture of this sequence shows the ball near one edge of the screen. Then, after an interval of darkness, the ball is seen a trifle further from the edge; following another moment of darkness the ball is shown still nearer the center of the screen—sixteen such pictures, each showing the ball in a different position, may be projected in one second, and the optical effect is that of the baseball in smooth and continuous motion, crossing the screen in one second's time.

To secure this result, a vast number of pictures are photographed on a long strip of celluloid, through which the projection light is thrown. A thousand or two thousand feet of this film, wound up on a metal reel, are encased for operation in the upper magazine of the projector. The first few feet of the film are threaded by the projectionist, through the gears of the projector mechanism, and the end fastened to a similar metal reel in the lower magazine. A row of sprocket holes stretches along each edge of the film, and are engaged by the teeth of sprocket gears which cause it to move through the projector when the drive motor is started. The film winds from the upper magazine, down through the projector and the beam of light piercing it, and is reeled up in the lower magazine. The speed of the film is 90 ft. per minute; 16 of the pictures photographed upon it appear before the projection light in one second's time.

The dark intervals, during which one picture is removed from the light aperture and another inserted, are secured by means of a shutter synchronized mechanically with the motion of the film. The film does not move steadily but jerkily, because each picture, during the instant it is being projected, must be perfectly motionless.

With these elementary requirements in mind, let us glance briefly at the mechanism that conforms to them, not out of any special interest, at this time, in the mechanism itself, but primarily as a guide to realizing what training and background the projectionist must have had in order to deal properly with such apparatus.

Light Projection Equipment

The necessary light is commonly secured by means of an arc between carbon electrodes (in small theatres incandescent lamps of 1000 W. may be used). A curved mirror helps concentrate the light upon the condenser. The arc uses from 40 to 100 V., and from 15 to 200 A., depending upon the amount of light required. Although in a few experimental installations A.C. arcs are used at this writing, projection arcs commonly require D.C. to secure steady light, and this is drawn from city mains, from a motor-generator, or from a rectifier. The projectionist is, therefore, familiar with handling current in fairly large quantities, and with choosing appropriate wire diameters and insulations.

Because the carbon electrodes burn away, the distance between them must be readjusted every minute or so. This is done automatically by a relay that starts a small "arc-feed" motor whenever the resistance of the arc increases. The same motor also causes the positive electrode to rotate, in order to compel it to burn away evenly, and avoid flickering of the light. (Dirty relay contacts, or a dirty commutator on this motor, often create sparking noises in the sound.)

Genuine DeFOREST Tubes

410 450 481

These Tubes are
all guaranteed
first class Mer-
chandise.

95¢
EA.

SUBJECT TO PRIOR SALE

A R R O W

SALES CORPORATION

549 W. Randolph St. Chicago, Ill.

WANTED!

Jobbers—Mail Order Houses and Representatives
in all Territories

TWO FAST MOVERS



Free Edge Cone and Voice Coil Assemblies for all Dynamic Speakers. We also Manufacture Various Types of Magnetic Speakers. We can Supply and Remedy Your Speaker Needs. Speaker Mfrs. Since 1921

LEOTONE RADIO CO., 63 Dey St., New York, N.Y.

NEW! SENSATIONAL! 110 VOLTS AC FOR AUTOS

The new AUTONATOR generates 110 Volt A.C. Current in motor cars, aeroplanes and from all types of engines and motors, direct from fan belt. Costs nothing to operate. No service—no brushes, collector rings, commutator or wire around armature. Ideal for generating PORTABLE Sound Equipment, A.C. Radio Sets, Neon Signs, Electric Lights, Searchlights. Send for complete details.

AUTONATOR LABORATORIES, INC.
8440 South Chicago Avenue Chicago, Illinois

SERVICEMEN! THE MOST COMPLETE LINE OF CONDENSERS AND RESISTORS FOR EVERY RADIO USE

Write for our new 30-page Catalog folder free of charge

AEROVOX

CORPORATION

76 Washington Street

Brooklyn, N. Y.

TESTING EQUIPMENT

We buy, sell or trade new or used Radio Service Equipment. Complete line of parts and supplies.

H. WAECHTER DISTRIBUTOR

HARPER

IOWA

10¢ A DAY BUYS A NEW REMINGTON PORTABLE TYPEWRITER

Special 7-Day Free Trial Offer

Think of it! You can buy a new standard Remington Portable Typewriter for but 10c a day. Standard keyboard. Small and capital letters. Beautiful finish. Carrying case included free. Exceptional money-making opportunities. Write today. Say: Please tell me how I can get a new Remington Portable typewriter on your special 7-day free trial offer for but 10c a day. Remington Rand Inc., Dept. RC-7, Buffalo, N. Y.



BACK ISSUES OF RADIO-CRAFT which you might need to complete your files, can still be had at the price of 25c per copy. Send us your requirements, together with your remittance in check or money order.

RADIO-CRAFT, 96-98 Park Place, New York, N. Y.

Rectifiers used for arc current supply commonly consist of rectifying tubes, sometimes of 30-ampere size, in a full-wave circuit. More recently "dry chemical stack" or dry-disc rectifiers have come into use for this purpose.

The projector mechanism is both intricate and delicate. The irregular motion required of the film calls for a complicated system of gears, so accurate in their operation that the fragile celluloid neither tears nor jams. (Either, under the intensity of heat focussed on the film, will result in fire, in a split second.) The advent of sound has increased the complexity of the gearing, for when a photo-cell is used the sound track must pass the "sound aperture" without the faintest trace of jerkiness in its motion; otherwise the pitch of the sound will vary. Worn or improperly lubricated gears not infrequently give rise to such "flutter" or "wows."

OPERATING NOTES

(Continued from page 478)

SPARTON 14

A COMPLAINT of hum and distorted reproduction was received recently on a Sparton model 14. As the most common cause for hum on these or any other receiver employing dry electrolytics lies with the filter condensers (as this type dry up and lose their effective capacity) both these units were replaced. After this was done, the receiver was switched on, and operation was normal and hum-free. The day after, however, the same complaint came in and another call had to be made. Upon arrival, as no hum could be detected, information solicited from the owner disclosed the fact that at times the condition would not present itself until after ten or fifteen minutes of operation, while at others, the hum would start in at the snap of the switch.

After a short time, things began to happen. A low, insistent hum soon became louder and reception became distorted, with the additional circumstance of a pentode output tube with red-glowing grids. This latter symptom, an indication of excessive plate current, could have been caused (discounting defective tubes for these had all been checked) either by a lack of negative grid bias or a positive potential being impressed upon the control-grid, the latter ordinarily being the result of a leaky coupling condenser. Although this condenser tested satisfactorily, to eliminate any possibility of a breakdown under load, a new .01-mf. unit was installed. The next step was measurement of the control-grid bias; but because of the extremely high resistance in this grid circuit of this tube, it was impossible to obtain a true and correct reading of the potential impressed upon the grid. See Fig. 2. Measurements had to be made from the chassis to the tap on the field coil, which is connected in the negative return of the high-voltage winding. The voltage reading obtained was 2 V.; the drop across the entire field was only about 40 V.

The speaker plug was disconnected and an ohmmeter showed the field resistance to be about 2,500 ohms with the tap about 400 ohms, which was as it should have been. This state of affairs proved disconcerting as the only other reason for a low-voltage drop across the field was a faulty voltage divider system, whose components had checked correctly only a few moments before. This left the field coil as the only possible cause for the trouble.

When the speaker plug was re-inserted and the switch turned on, the receiver operated without hum or distortion and some more time had to be spent until the hum would again develop. It did. The voltmeter connected across the field showed a reading of about 30 V., whereupon the speaker plug was quickly removed. This time, a reading of approximately 500 ohms was obtained across the speaker field, and it was found that by pressing upon the coil winding, the resistance could be made to vary! As soon as the coil had cooled, which only took a moment or two, the resistance was again 2,500 ohms. A new field coil was installed on a subsequent visit.

INTERNATIONAL RADIO REVIEW

(Continued from page 461)

out. This eliminates one source of distortion.

No actual data were given and since the tube specified in the article cannot be obtained in the U. S., it is necessary for the experimenter to work out the details himself.

AN ULTRA-SELECTIVE SUPERHET.

THIS receiver, Fig. 9, is described in *FUNKTECHNISCHE MONATSSHEFTE* (Germany) as a combination of a broadcast and a long-wave superheterodyne with a short-wave adapter, both built in the same chassis. Through a switching arrangement, the adapter can be connected to the superhet, the range of which is thus increased from 200-2,000 to 20-2,000 meters.

One of the interesting features of this set is the use of a new hexode tube in the R.F. stage which has a variable mutual conductance which can be adjusted between 1 and 10,000. This makes it especially useful for A.V.C. action. Another hexode tube with somewhat different characteristics is used as a converter tube, similar to the pentagrid converters (2A7 and 6A7) used in this country. Two of the I.F. transformers are coupled together to form a band selector arrangement, to increase the selectivity of the receiver without cutting side-bands. A diode-triode tube is used as detector.

A 1 TUBE LOUDSPEAKER SET

THE circuit of Fig. 10 is a variation of the Megadyne circuit developed by Hugo Gernsback. The interesting features of the set other than those inherent in Megadyne receivers are:—the method of increasing selectivity by the use of a band selector; the method of controlling regeneration by the use of a potentiometer connected across the feedback coil, and the method of supplying current to the "pentode in reverse."

Those interested in constructing this set should obtain a copy of the July, 1932 issue of *RADIO-CRAFT*, and make the necessary changes in the coils, etc.

SHORT CUTS

(Continued from page 469)

A STANDARD SIGNAL GENERATOR

John C. Bender

AFTER having watched the design and building of several factory signal generators, I decided never to attempt to calibrate one in microvolts until I could get enough money to buy a standard type of attenuator. The original generator circuit which I submit (Fig. 11) is equipped with a calibrated attenuator but due to the complicated network used and the trouble in designing such a unit, I shall leave out this part.

The oscillator coils are wound on standard Silver-Marshall, hexagonal forms. Each coil is center-tapped for the "B" lead. It will be found that the best working voltages for this type are 45 V. on the R.F. plate and 67½ V. on the plate of the A.F. oscillator.

In constructing this generator, use "floating" grounds. In other words, mount all parts on an insulated panel and keep all grounds of the circuit away from the ground of the shielding. Bring each ground lead (of the oscillator) to a common point and out through a small hole in the rear of the shield. It would be wise to insert an R.F. choke in this lead, *inside the shield*, and connect two 1 mf. condensers, one on each side of the choke, to the common ground on the shield.

It will also be noticed that the A.F. coupling is obtained through the grid of the 33 tube. The lower the impedance of its transformer secondary, the more stable the R.F. But don't forget that there must be quite a voltage transfer here, due to the power of this R.F. oscillator. The writer advises a one-to-one ratio transformer or an S.M. 270 V. transformer. Mount all batteries in a small shielded compartment of the generator and bring all battery leads out through shielded cables.

FREE Handbook OF SERVICING SHORT-CUTS



and monthly bulletins that keep it always up-to-date!

Get this valuable inside dope that only Sylvania offers you free of charge! There's a meaty, 64-page booklet with tips from other service men on how to correct the troubles most apt to occur in each model of the leading radio sets.

And every month, a copy of Sylvania's Service Bulletin brings you additional tips . . . as well as the latest general news in the industry. It tells you, too, how you can cash in on your own experience . . . get free tubes by sending in your own pet short-cuts.

Just fill in the coupon and mail it today. Sylvania will send the handbook, and a new bulletin every month as a complimentary service!

MAKERS OF

Sylvania Tubes Hygrade Lamps
Electronic Devices

FACTORIES

Emporium, Pa. St. Marys, Pa.
Salem, Mass. Clifton, N. J.

SYLVANIA

The Set Tested Radio Tube

Sylvania

THE SET-TESTED RADIO TUBE

HYGRADE SYLVANIA CORPORATION B-7
Emporium, Penna.

Please send me your free booklet "Service Hints" and your free monthly Service Bulletin.

Name

Address

City..... State.....

RADIO for 1934

NO SERVICEMAN DEALER
OR SET BUILDER CAN AFFORD
TO BE WITHOUT THIS BOOK

Send for the most valuable book in Radio. Packed with quality and value. Lists the most complete line of radio replacement parts for any service requirement. Features latest type set-building kits, test instruments, Long and Short Wave Radios, Sound Systems, etc. Write for this FREE Catalog today!



FREE

ALLIED RADIO CORP.,

Dept. D, 833 W. Jackson Blvd.
Chicago, Illinois.
Please send me FREE your New 1934 Radio Book.

Name

Address

City State

Allied Radio

Be Thrifty — Use the Model 500 SUPER TEST UNIT



Unit Analyzer

PRICE ONLY
\$13⁸⁵

Net to Dealers and Servicemen
LIST \$25.00

The wise serviceman saves and gets better results by connecting a SUPER TEST UNIT to his multiple-reading meter of Multitester or he uses the meter in his obsolete analyzer with the SUPER TEST UNIT. This makes him the owner of the most modern and efficient analyzer ever devised. It eliminates the need for a high priced analyzer fitted with an expensive meter. The simplicity of the SUPER TEST UNIT is immediately apparent. Selector switches make it easy to use. Socket terminals and circuits are clearly etched on panel. No complicated directions needed. No plugging of connectors into jacks. The SUPER TEST UNIT cannot become obsolete. It contains a 10-wire analyzer cable and is equipped with 8-9 prong sockets. Switches have additional points for reserve capacity.

Make every modern test including conventional current-voltage analysis and complete point-to-point analysis giving both resistance and voltage measurements. Any circuit or point may be used as a reference point. Also provides an accurate "Grid-Shift" tube test. Complete with analyzer plug and 4, 5, 6 and 7 prong, "Sure-Full Out" adapters.

KNOCK DOWN \$10.85 Complete with instructions. Net to dealers and servicemen.

Regular List Price \$20.00

Send for free data sheets on Super Test Unit, Dependable Tube Tester, Multitester and other quality radio servicing instruments.

RADIO CITY PRODUCTS CO.
48 West Broadway Dept. RC New York, N. Y.

A "2B6" AMPLIFIER

(Continued from page 479)

19 V. is the actual alternating potential difference between grid and cathode. However, the D.C. potential difference between these two points is 24 V., which is more than adequate to prevent the flow of grid current.

The self-biasing resistor, R8, is shunted by a 25 mf. electrolytic condenser to avoid degenerative effects.

The recommended plate voltage of the 2B6 tube is 250 V. However, in this amplifier, a plate voltage of 200 V. has been selected after considerable research, since it has been found that this increased voltage makes possible a higher output, without detriment to the performance or efficiency.

Using the 2B6 amplifier, a very low-priced P.A. system of considerable power can be assembled. For example, the amplifier sells for less than \$18 complete with tubes. Adding a medium-priced, single- or double-button microphone, a suitable matching transformer, two dry cells, a phonograph pickup and turntable, and the required number of dynamic reproducers, the complete system is available at about the same cost as formerly charged for an amplifier of the same power output but without the other necessary equipment.

Another interesting use proposed for this efficient little amplifier is in conjunction with a radio tuning unit. In his arrangement either the first tube in the A.F. amplifier may be used as a detector, instead of first A.F.; or, the detector may be incorporated in the separate tuner. This is the latest idea in radio set design, in which the tuner and detector are installed in a small, remote cabinet.

The writer has spent many months in developing and perfecting this little amplifier and naturally after all this research, he is well acquainted with its capabilities. Service Men, or others who contemplate its use in connection with specialized P. A. jobs, and who desire additional information, are invited to write in care of this publication, as he will be glad to give them the benefit of his technical knowledge and experience.

List of Parts

- One Trutest resistor, 1/2-meg., 1/2-W., type E-4257, R1;
- One Trutest resistor, 1000 ohms, 1/2-W., E-4256, R2;
- One Trutest resistor, 1 meg., 1 W., type E-4338, R3;
- One Trutest resistor, 1/4-meg., 1/2-W., type E-4285, R4;
- One Trutest resistor, 10,000 ohms, 1/2-W., type E-4269, R5;
- One Trutest carbon resistor, 1 meg., 1/2-W., type E-4288, R6;
- One Trutest carbon resistor, 8,600 ohms, 1 W., type E-4318, R7;
- One Trutest special resistor, 540 ohms, 10 W., R8;
- One Trutest special fixed condenser, 5 mf., 35 V., C1;
- Two Aerovox tubular condensers, .1-mf., 400 V., type D-3925, C2, C3;
- One tubular condenser, .5-mf., 400 V., type D-3220, C4;
- One Trutest cartridge electrolytic condenser, 25 mf., 50 V., C5;
- One Trutest double electrolytic condenser, 8 mf. and 4 mf., 500 V., type D-3335, C6, C7;
- One Trutest special 30 hy., 60 ma., choke, Ch.;
- One Trutest special power supply transformer, 375 V. either side of center tap; one 5 V., 3 A. filament winding; one 2 1/2 V., 1 A. filament winding; and one 2 1/2 V., 2 A. filament winding, T1;
- One type 57 pentode tube and one 6 prong wafer socket, type M-13071, V1;
- One 2B6 power amplifier and one 7 prong wafer socket, type M-13069, V2;
- One 5Z3 full-wave rectifier and one 4 prong wafer socket, type M-13070, V3;
- Two input twin jacks, type M-13030, J1, J2;
- Two output twin jacks, type M-13031, J3, J4;
- One S.P.S.T. toggle switch, type M-12832, S.W.1;
- One metal chassis—8 x 6 x 2 1/2 ins. high, crackle finish;
- Miscellaneous hardware, hook-up wire, etc.;
- 6 ft. connector cord and plug.

Increase YOUR SERVICING BUSINESS 25%

If you are overlooking servicing auto radios, then you're missing a great deal of business. The auto-radio business had its greatest boom this past summer and thousands of sets were sold. By this time many of these same sets require servicing and with hundreds of them right in your own community, you can build up a good auto-radio servicing business. In a short time you can easily add 25% or more to your regular servicing business.

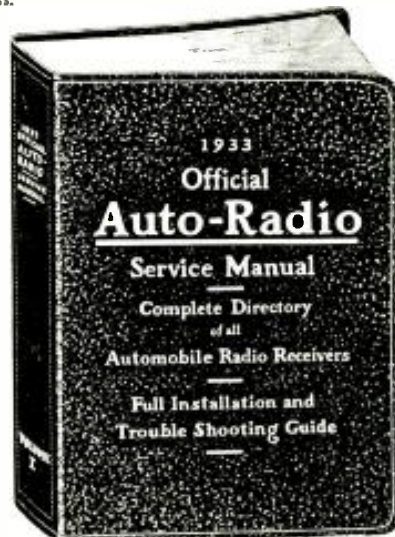

\$2.50 A Copy

Every man connected in any way with the booming auto-radio business will want a copy of this book immediately. It is devoted exclusively to auto-radio service "done" in complete, understandable form. The OFFICIAL AUTO-RADIO SERVICE MANUAL contains schematic diagrams, chassis layouts, mounting instructions, and trouble shooting hints on all 1933 and many older model auto-radio receivers. This Manual contains a "goldmine" of information.

List of Sets Covered in the Manual

Atwater Kent Mfg. Co.	Chas. Hoodwin Company
Autorat Radio Company	Montgomery Ward & Co.
Carter Genemotor Corp.	National Co., Inc.
Chevrolet Motor Company	Phileo Radio & Tel. Corp.
Crosley Radio Corp.	Pierce-Airo, Inc.
Delco Appliance Corp.	Premier Electric Co.
Emerson Electric Mfg. Co.	RCA-Victor Co., Inc.
Federated Purchaser, Inc.	Sentinel Radio Corp.
Fada Radio & Elec. Corp.	Sparks-Whittington Corp.
Ford-Majestic	Stewart Radio & Tel. Corp.
Franklin Radio Corp.	United Amer. Bosch Corp.
Galvin Mfg. Corp.	United Motors Service
General Electric Co.	U. S. Radin & Tel. Corp.
General Motors Corp.	Wells-Carrier Company
Grigsby-Grunow Co.	Zenith Radio Corp.

Over 200 Pages
Over 500 Illustrations
9x12 Inches
Flexible, Loose-Leaf Cover

Mail This Coupon Today!

GERNSBACK PUBLICATIONS, Inc. RC-234
96-98 Park Place, New York, N. Y.

Enclosed you will find my remittance of \$2.50 for which please send me one copy of the 1933 OFFICIAL AUTO-RADIO SERVICE MANUAL. (Send remittance in check or money order. Register letter if it contains cash or currency. WE PAY POSTAGE.)

Name

Address

City State

AIRPLANE RECEIVER AND 5 METER TRANSCEIVER

(Continued from page 465)

Trim featherweight headphones. A trailing antenna is used; when not in use it is wound onto a reel. The set consumes 1.55 A. at 12 V.; the weight is about 20 lbs., complete with "P" unit but without the 12 V. power supply. A superheterodyne circuit is used. The tube complement includes one type 78 R.F. amplifier; one 6E7 first-detector and oscillator; two 78 R.F. amplifiers; and one 6E7 diode-detector, A.V.C. and output tube.

Construction

Before discussing the theory involved in the design of the radio equipment, we will give actual construction data concerning the transceivers, since these units were built especially for Miss Gentry's airplanes.

Having assembled exactly the material specified in the List of Parts, proceed to mount the apparatus in accordance with the interior views of the instrument, Figs. D and E. Figure D is a rear view of the transceiver in the upright position; the layout of the parts approximately corresponds to the arrangement of the parts in the schematic circuit, Fig. 1.

The tubes in the instrument are reached, for replacement, by removing the bottom cover-plate of the aluminum cabinet; the tubes then may be pulled downward, out of the sockets. Since the sockets specified in the List of Parts grip the tube prongs like Grim Death, the tubes cannot possibly be vibrated out of their sockets. Now tip the panel forward so that you have a good view of the tubes, and you can locate the various under-sub-panel components by reference to Fig. E. Therefore, the various parts located under the sub-panel will still correspond, approximately, with their positions as indicated in the schematic circuit, Fig. 1.

These transceivers had to be made up in such short time that the authors could not even wait for the various parts to arrive from the different manufacturers. Coils L1, L2 and L3 were hand wound, as was the R.F. choke, R.F.C. If the constructor desires to follow our practice, he has our sympathy, for the construction of these coils consumed considerably more time than was expected. Details are given in Fig. 2A. The suppressor-frequency coils are shown in Fig. 2B. The R.F. choke is illustrated in Fig. 2C.

The power supply was designed to be replaced by the exchange, in mid-air, of battery containers. One of these containers is clearly shown in Fig. 4; the batteries are

(Continued on page 507)

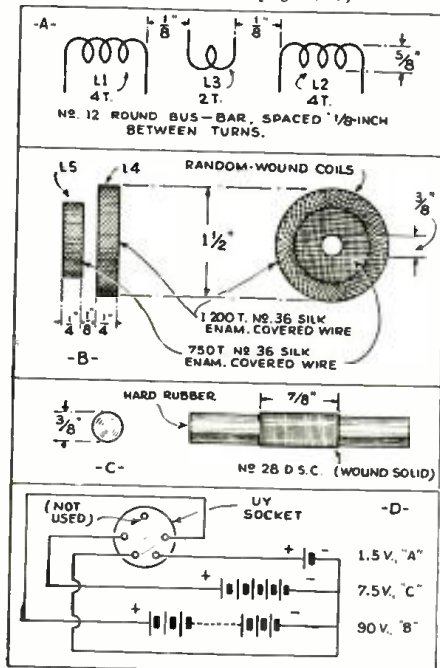
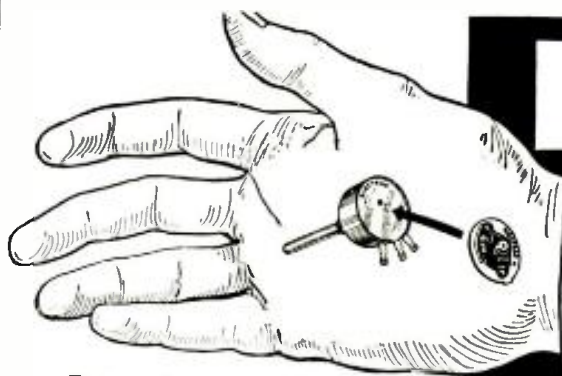

Fig. 2

The details of the tuning, suppressor frequency, and R.F. choke coils; and battery connections.



Convertible

Replacement
**VOLUME
CONTROLS**

**Interchangeable
End Cover and
Power-Switch Assembly**

ELECTRAD Replacement Volume controls have distinctive economy and time and labor-saving features which appeal to the busy service man.

End covers can be snapped out and replaced *instantly* with a power-switch assembly, if desired, without disturbing control connections.

The shafts are extra long ALUMINUM, easily cut to desired length.

Only five types required in the service kit to fit 799 standard receiver models.



FREE
Write Dept. RC-2 for
Catalog and Vest-Pocket
Volume Control Guide.



Sturdy, Low-Priced

WIRE-WOUND 10-WATT

Vitreous enameled, non-porous. Rapid heat dissipation. Monel Metal contact bands and lugs. Size 3/8" x 1 1/4" — 41 resistance values — 35 cents each.

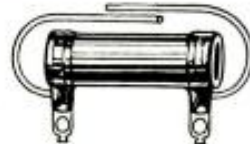

POWERFUL WEBSTER 15-WATT CLASS "A" AMPLIFIER

MICROPHONE
CURRENT

MASTER
VOLUME
CONTROL

VARIABLE
OUTPUT
IMPEDANCE

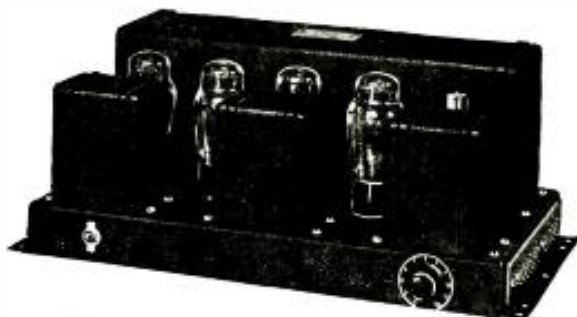

In the Series 358 Webster introduces an altogether new standard of excellence in Amplifier Equipment. Built around the new tubes and with the incorporation of new ideas in construction, this amplifier will show a greater utility in daily application on sound problems. Moderately priced yet powerful enough for all systems, dance halls, athletic fields, churches, schools, etc., the Series 358 most nearly meets the needs of sound installation engineers. Write for complete details.

CLASS "B" 26 WATT

In the class B type equipment of the Series 358 Webster provides a definite advance. This new equipment will handle a tremendous volume of undistorted out-put. Easily pushes four or five giant dynamic speakers. Write for complete description.

THE WEBSTER COMPANY

3830 WEST LAKE STREET

CHICAGO, ILL.

FREE Catalogue describing the entire Webster quality line of P.A. Equipment so moderately priced you will be surprised.

WRITE NOW.

THE WEBSTER CO.

USE THE COUPON

3830 W. Lake St., Chicago, Ill.

Gentlemen:—I am a Dealer, Serviceman, P.A. Specialist and want all information on your Series 358 Amplifiers.

Name

Address

City State

Make MORE MONEY in RADIO with R.T.A. Professional TRAINING

Home study with R.T.A.—plus lifetime membership in our large, powerful association of radio service men—brings you up to date on all improvements in radio, television, sound engineering, and keeps you among the real money-makers in this expanding field. Unless you have this high-type professional training you will find it hard to get out of the poorly paid "tinkerer" class.



New-Type Set Analyzer Included

As part of R.T.A. training you get this up-to-the-minute Set Analyzer and Trouble Shooter. After a few easy lessons you are ready to use it for immediate money-making, competing with "old-timers" without fear. With this wonderful piece of equipment, backed by R.T.A. professional training, you need have no fear or worry over the future. Even though there should never be a new radio set constructed—or not another improvement in radio made—there are enough sets now in service that need frequent attention to assure you good money as an accepted Radio-technician.

Start Money-Making Quickly

R.T.A. Training is especially designed—and given you by one of the outstanding teachers of radio technology in the world—to get you into the profitable end of radio quickly. It is not empty theory, but practical, down-to-earth work that makes you a money-maker in this immense field in the shortest possible time. Don't delay your start toward success. Write at once for all details about R.T.A. training. The Coupon below brings FACTS—astonishing ones that may open up a new, depression-proof future for you.

MAIL COUPON NOW!

RADIO TRAINING ASS'N. OF AMERICA,
4513 Ravenswood Av., Dept. RCR-2, Chicago, Ill.

Send me all the FACTS about R.T.A. professional training together with information about the opportunities existing for R.T.A. Radiotechnicians today.

NAME.....

ADDRESS.....

FORDSON CATALOG

Deal Direct
and Save
1/2 to 1/3
FREE

Enjoy the performance of ANY FORDSON MODEL in YOUR OWN HOME FREE for 30 DAYS. Thousands sold around the world. An owner writes: You are doing for Radio what Henry Ford did for Auto industry—Not how cheap but how Good! Many models: AC-DC; battery; long and short wave; all-wave supers; 6 and 32 volt; consoles; all-electric auto radio. Sets for home, car, camp, farm and export. GUARANTEED! 30-DAY FREE TRIAL in YOUR HOME. A postcard or the coupon brings the REMARKABLE NEW CATALOG FREE. Send today! Prices will amaze you.

\$8.95 up
MAKE MONEY as our agent. No experience needed. 2-color literature and cards (with your name) all FREE. Agent's sample sets FREE. Write! Send card or coupon now!

FORDSON RADIO MFG. CO.
Dept. 2, 11700 Livernois Ave., Detroit, Mich.

Send me FREE catalog and agent's proposition (this is not an order).

NAME.....

ADDRESS.....

STUDY UP ON THEATRE Sound Devices

World-Famous 3 Volume, "Sound Projection," "Stereoscopic Projection" and "Simplified Servicing of Sound Equipment." Original Value, \$15.00. Set of 3, \$2.95; Individually \$1.19 each.

World's Largest Theatre Supply House

S. O. S. CORPORATION

1600 BROADWAY NEW YORK, N. Y.

MAKING A 9-TUBE A.C. T.R.F. SET

(Continued from page 471)

tube would result in a 50 V. positive bias on the control-grid. However, the normally combined plate and screen-grid currents result in a 56 V. drop through R6 with no signal inputs; the figure rises to between 57 and 59 V. for normal inputs and about 60 for maximum; thus placing a negative bias of between 6 and 10 V. on the detector control-grid (the difference between the cathode to negative and the control grid-ground to negative voltage).

The other point is that with V6 control-grid connected to V4 cathode, V6 control-grid is actually 6 V. above ground with no signal and an average 7 1/2 V. with normal operation. To counteract this and to maintain correct bias voltage on V6, additional self-bias resistance is inserted in the V6 cathode return circuit so that normally V5 measures about 13.5 V.; whereas V6 measures about 20.5 V. The actual grid-to-cathode bias, however, is V5, 13.5 V.; V6, 13 V. With a lower plate voltage on V6 this 1/2-V. bias difference is correct. No cathode-to-ground bypass condensers have been used in the V5, V6 circuits, since these so-called degeneration-control condensers are rendered unnecessary by the properties inherent in a judicious choice of the value of C4, and since at lower frequencies where a degeneration bypass would be needed in a single-sided amplifier—in this set operation is push-pull.

IV—The interstage transformer T1 acting as a mixing transformer in this set (the composite of the two 56 outputs) from this point on are blended in true 100% push-pull. A word of caution is essential in the choice of a transformer here. Since at large outputs the 2A3 draws grid current, a transformer with a large core cross-section and a low secondary resistance would function with least distortion.

Of the 2A3, little is worth noting, except that it is far more critical to match tubes for a push-pull stage using this tube than with a conventional 100% class A operating tube.

A set such as this imposes especially severe demands on the power unit. The current drain is large. Peak loads momentarily may reduce voltages sufficiently to affect the operation of the entire set and to seriously alter biases in an amplifying stage as critical as V6. The maintenance of close operating limits is a prime necessity on a power pack for a set such as this. Its achievement is always an economic compromise. In this set, the use of a heavy power transformer and a rectifying tube with a low internal resistance (the 5Z3) is the correct foundation for further building. The rectifier is followed by a filter system, which, to reduce reaction of the power stage currents on the rest of the set is divided—a separate filter circuit being used for the power stage, the speaker field and two electrolytic condensers, and another circuit for the tuner and voltage amplifier which consists of two very small high-inductance chokes and three electrolytics, the first or input electrolytic being common to both arms. This scheme results in the voltage amplifier current being maintained within 5% throughout the full volume range despite a power amplifier fluctuation of about 10 to 15%.

To maintain correct filament voltage on the 2A3's was found difficult at first—since in the original set the power transformer used was made for 45's. However, by paralleling the filament windings, adequate voltage was secured. To determine which is the correct connection, the light and heavy 2 1/2 V. windings are connected tentatively in series and the open ends tested with a voltmeter; if the voltages add, to connect the free terminals together would result in a short circuit; reverse the connected ends of one coil and then test again. The reading should be close to zero. Then the remaining free ends can be connected together and the parallel windings used to feed the filaments of the set. Another quick check on the correct connection of the two windings is to connect the two free ends of the 2 1/2 V. windings and to

WORLD'S FINEST PHOTO-INSTRUMENT



In all the World No Other Camera Like This!

The only Quick-Acting, Automatic Winding, Ground Glass Focusing Camera using Standard Roll Film. Good for all purposes. No Separate Parts or Attachments are Necessary!

No Double Exposures with "PAL KO"!

It THINKS and COUNTS for you. Used by U. S. Government, Educational Experts and Leading Publications. Simple! Positive! Dependable! 3 Cameras in One! "PAL KO" takes full postcard 3A, or 2/3 or 1/3 this size—19 pictures on a six exposure film!

SAVINGS ON FILMS ALONE WILL SOON PAY FOR "PAL KO"
SATISFACTORY PERFORMANCE GUARANTEED OR MONEY REFUNDED!
SOLD DIRECT FROM MANUFACTURER TO YOU
WRITE TODAY FOR FREE CATALOGUE

PAL KO, Inc.

817 Wash. Blvd. CHICAGO Dept. R-2

CLASSIFIED ADVERTISEMENTS

AUTOMOBILE WANTED

WANTED: 57 PASSENGER AUTOMOBILE in perfect condition—heavy car equipped in exchange for brand new, complete 26 watt output amplifier system (worth \$600.00). Operates from 6-volt storage battery or from 110 volt A.C. or both. Miller, Apt. 101B, 639 West End Ave., New York, N. Y.

ELECTRICAL

FORD MODELS T AND A, Chevrolet Delco, and Dodge 12-V generators changed to 110-V alternating current generators. The 12-V generators to 500-W SELF-EXCITED, or to 32-V, 500-W D.C. Also Ford T to 32 and 110-V D.C. motors. Complete information all in ONE BOOK, with simplified drawings and illustrations. Book only \$1. (cash or M. O.). Antopower, 410 S. Hoyne Ave., Chicago.

INSTRUCTION

RADIO HOME STUDY COURSE—FAMOUS Radio Doctors Course: 58 lessons, over 500 illustrations with supplementary service data and genuine blue prints. Hundreds sold for \$79.50. Complete course shipped prepaid \$7.50. Examinations included, but not corrected. Order now, supply limited. Liquidating Agent, Eugene Parker, Pierce Avenue, Salem, Mass.

RADIO

RADIO PARTS—WE CARRY EVERYTHING for receiving and transmitting. Wedel Company, Inc., Wholesale, Seattle, Washington.

TUBELESS CRYSTAL SET. SOMETHING new. Separates all stations. Operates speaker. 750 miles verified. Blueprint, 6 others, 25c coin. Modern Radiolabs, 151-B Liberty, San Francisco.

4-TUBE SW RECEIVERS, POWER SUPPLY, \$18.90. 2,000 Bargains, catalog 10c. Mid-Con, 3007 Main, Kansas City, Mo.

SONGWRITERS

SONGWRITERS! Poems, melodies. Amazing opportunity. Hibbler, D153, 2104 Keystone Chicago.

SEXOLOGY

THE MAGAZINE OF SEX SCIENCE

SEXOLOGY, foremost educational sex magazine, is written in simple language and can be read by every member of the family. It is instructive, enlightening—not a risqué book—contains no jargon. Devoted to Science of Health Hygiene.

Contains 25 important articles on Sex Science, 68 pages, with attractive two-color cover. Here are a few of the more important articles: Extra Breasts in Women (Illustrated); Pregnant Grandmothers; Gonorrhea—The Great Enemy (Illustrated); An Embarrassing Female Complaint; The Prostate Gland (Illustrated); "Safe" Periods of Women; Sex Defect of Louis XVI; Syphilis and Heredity; The Fourth Sex; Proving Parentage; Incest and Its Origin; Gland Transplantation; Premature Sex Development; Dangers of Delayed Marriage.

Get a copy of SEXOLOGY on any newsstand, or, if your dealer cannot supply you, send 25c in stamps for a copy of the current issue.

SEXOLOGY 25R West Broadway New York, N. Y.

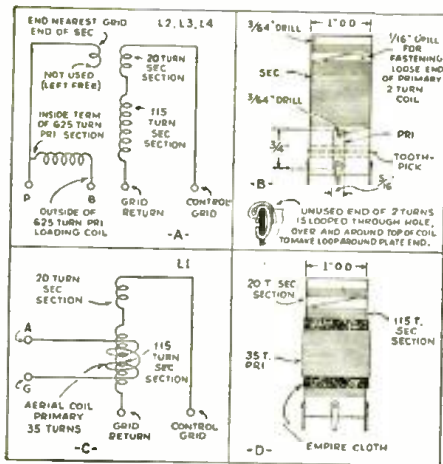

Fig. 2

The coil details for R.F. and oscillator.

quickly snap the free ends together. The connection giving no spark is the correct one and should be used. By this means, the voltage supplied to the 2A3's was raised from 2.05 V. to 2.4 V., using an ordinary inexpensive transformer intended for lighter work than in this set. Another worthwhile point to consider in wiring the set is to run separate filament leads; one line for the 58's and 57's; one for the 56's; and one for the 2A3's.

Build this set, but make up your mind to use only components that will stay at their rated values.

List of Parts

- One 320 mmf. variable condenser, 4-gang (to tune coils L1 to L4), C1;
- Five condensers, .25-mf., 200 V., paper, C4, C7, C10, C12;
- One condenser, 0.1-mf., triple unit, 200 V., paper, C2, C5, C8;
- Three condensers, .25-mf., 400 V., paper, C3, C6, C9;
- One condenser, 0.2-mf., 200 V., paper, C11;
- Two condensers, .250 mmf., mica, C14, C15;
- One condenser, .002-mf., mica, C16;
- One condenser, 0.1-mf., 400 V., paper, C13;
- One condenser, 10 mf., 100 V., electrolytic, C17;
- Two 8 mf., dual unit, condensers, 500 peak V., electrolytic (negative insulated from chassis), C18, C19, for hum control if needed C20 .1-mf., 200 V.; C21 same as C17, 10 mf., 100 V., electrolytic;
- One resistor, .15-meg., 1/4-W., carbon, R1;
- Five resistors, 25,000 ohms, 1/4-W., carbon, R2, R3, R4, R5, R6;
- One resistor, .25-meg., 1/4-W., carbon, R8;
- Four resistors, 15,000 ohms, 1/2-W., carbon, R9, R10, R11, R12;
- One resistor, 85,000 ohms, 1/2-W., carbon, R13;
- One resistor, 80,000 ohms, 1/2-W., carbon, R14;
- Four resistors, 0.4-meg., 1/4-W., carbon, R15, R16, R17, R18;
- Two resistors, 1,500 ohms, 1/2-W., carbon, R19, R20;
- One resistor, .25-meg., 1/2-W., carbon, R21;
- One resistor, 10,000 ohms, 2 W., carbon, R22;
- One resistor, 10,000 ohms, 5 W., wire-wound, R23;
- One resistor, 3,000 ohms, 15 W., wire-wound (adjustable; Electrotype B-30 is suitable; one extra slider is needed), R24;
- One resistor, 20,000 ohms, 35 W., wire-wound (adjustable; Electrotype C-200 is suitable; two extra sliders are needed), R25;
- One resistor, 800 ohms, 10 W., wire-wound, R26;
- One resistor, 0.1-meg., graphite variable resistor (for tone control), R27;
- One antenna coupler (ready-made or as per Fig. 2), L1;
- Three R.F. transformers (ready-made or as per Fig. 2), L2, L3, L4;
- Two R.F. choke coils for broadcast band (manufactured, or as per Fig. 2), L5, L6;
- One interstage push-pull to push-pull transformer, T1;

One power transformer (must have a 5 V., 3 A. winding; one or more 2 1/2 V., windings to supply 12 A.; method of paralleling 2 1/2 V. windings described in text; and one 375-0-375 center-tapped high-voltage winding, 125 ma.; preferably equipped with a tapped primary for "hi-lo" line voltage connections, T1);

One dynamic reproducer equipped with output transformer, T2 (1000 ohm field);

Two 20 hy. chokes, 45 ma. (not over 500 ohms resistance), Ch1, Ch2;

Four tube shields;

One Blau chassis base (large size, for 9 tubes and speaker socket);

Three type 58 sockets;

One type 57 socket;

Two type 56 sockets;

Two type 2A3 sockets;

One type 5Z3 socket;

One speaker socket and 5-prong plug;

One antenna-ground binding post strip;

One tuning dial and escutcheon plate;

Knobs, screws and nuts, lugs and wire.

A 6 V. D.C. AND 110 V. A.C. 50 W. P.A. UNIT

(Continued from page 482)

The input posts, BP1 and BP2 are connected to volume and gain control resistor R22. The output of each pair of 57's is fed to individual class B output transformers, T2 and T4. Each one of which is equipped with the following secondaries: 500, 200, 15, 10, 8, 6, 4, 3 and 2 ohms.

To preclude the slightest possibility of hum, resistors R5 and R6 have been incorporated in the respective plate supply leads of the first and second A.F. stage 57 tubes. Each one of these resistors is completely bypassed by individual 4 mf., 500 V. electrolytic condensers, C2 and C5. This additional filter network supplements the action of the first brute-force filter system composed of filter chokes Ch1 and Ch2, 8 mf. electrolytic condensers C9 and C10, and a 1000 ohm 2 W. voltage reducing resistor, R20. The cathodes of the types 57 and 59 tubes are heavily bypassed with high-capacity electrolytic condensers in order to secure excellent low-frequency response.

Channel Filter Systems

To provide good voltage regulation and to insure distortion-free reproduction, as well as to permit the optional use of one or two channels, two separate brute-force filter systems are utilized (one in each channel).

Snapping toggle switch, Sw.2, to the ON position, connects the second channel "driver" 59 tube and its accompanying pair of 53 class B tubes to the output circuit of the first two type 57 tube A.F. stages. This provides the full 52 W. audio output. In the OFF position of Sw.2 the total output power available is only 26 W.

Switch Sw.2 does not cut off the plate or filament supply voltages to the second-channel tubes, consequently, it permits instantaneous use of this optional second channel as no "pre-heating" is required.

Two plugs, sockets and cable units, P1 and P2, and S1 and S2, provide the following types of procedure:

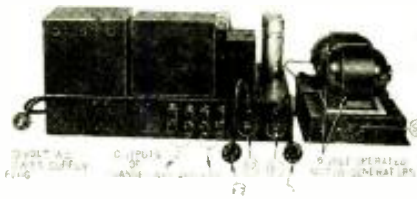

Fig. B

The appearance of the complete P.A. unit showing the motor-generators and the plugs for changing from 110 V. to 6 V. operation.

NOW!
MAKE MORE MONEY.
Save More Money...

...with
this better
ALL-PURPOSE
Tester!



Readrite

Voltage and Point-to-Point Resistance Tester No. 710

HERE is the tester you have been looking for! Here is the all-purpose tester that fills every need of both the expert serviceman and the radio beginner... in radio set testing.

New Features!

This new and improved tester is designed for testing new or old model radios. It is equipped with a practical selector switch for checking all parts of the set circuits by connecting to the set sockets. Selection for testing voltages of plate, grid, cathode, suppressor grid and screen grid is quickly and accurately done. Resistance tests are made in a similar manner. These same tests can be made directly with meter by connecting through jacks. Contains new wiring with added combination large and small 7-hole socket.

Plate current, filament volts, also line and power supply volts are measured. The battery is used for the continuity testing of transformers, chokes, etc. Capacity and resistance charts are furnished showing use of instruments for testing condensers, also for measuring resistances.

Only \$15.00 Net to Dealers
(List \$25.00)

Can be had in No. 711 with Triplett d.c. voltmeter having 1000 ohms per volt resistance at \$22.50 net. Your jobber can supply you at the dealer's net price. Try this amazing all-purpose tester one day, and you'll wonder how you got along without it.

NEW
catalog
FREE

READRITE METER WORKS

97 College Ave.

Bluffton, Ohio

Mail This Coupon TODAY!

Readrite Meter Works,
97 College Avenue,
Bluffton, Ohio.

Gentlemen:

Please send me information about Readrite No. 710 All-Purpose Tester. Also catalog of other servicing instruments.

Name

Street

City

State

it's New!

**S. E. C.
No. 92**

Electron Coupled OSCILLATOR



Servicemen, Dealers—are you looking for instruments to make your servicing easier, quicker and more profitable? Here is something worth while. The S.E.C. No. 92 OSCILLATOR, the third unit of a most dependable, compact and complete servicing set for testing radio receivers, amplifiers, etc.

Any one of the 3 units (No. 90 Universal Tester, No. 91 Analyzer or No. 92 OSCILLATOR) can be purchased separately or together in a Carrying Case with cable and adapters. Professional equipment at low cost. No. 92 is an electron coupled signal generator, 77x4 1/2"x2 1/2", 110 volt A.C. Covers frequencies 30 to 1600 K.C. without use of harmonics. Aligns and adjusts all types of receivers including "long wave" superhets which employ intermediate frequencies as low as 95 KC. Extremely accurate.

Our new bulletin describes this most useful TEST KIT (all three units) and is FREE for the asking. Write for your copy now!

SOUND ENGINEERING CORPORATION
416 N. LEAVITT ST. CHICAGO, ILLINOIS



Send for more
information

SOUND ENGINEERING CORP.
416 N. Leavitt St., Chicago, Ill.
Please send me latest FREE bulletin on SEC Test Kit.

Name
Address

Bargains in Parts

CLEARANCE SALE

Victor power transformers—genuine—models R-32, 52, RE-45, 55..... \$1.75
Victor condenser blocks—genuine—models R-32, 52, etc..... .95
Victor 30 by 1/2 filter chokes..... .49
Audios 3 1/2 to 1..... .39
Radiola power Transf., models 17—18—33—51..... 1.95
Radiola condenser blocks, models 17—18, etc..... .75
Jefferson ABC power transf. with choke, 500 V. a.c. 1.95
Jefferson power transf., 700 V. a.c., 125 m.a., for 11 tubes..... 2.98
Victor R.F. coils with chokes: ant. and R.F. types, each 8c

8 mfd. dry elec. condensers, carbid., 500V. guarant. .49
8 mfd. dry elec. condensers, can, 500V. guarant. .55
Tropisol tubular dry elec. condensers, .5 mfd., 200V. .16
Centralab 5M ohms volume controls..... .10
U. S. Radio power transf. horizontal mtg..... 1.39
Fresman voltage dividers, model N..... .49
Variable resistors, .25 meg.08

Speed radio tubes 50% and 10% off, types 46, 31, 33, 36, 37, 38, 39, 55, 57, 82, 883, 295 triple twin.

We are distributors for: Electro, Ward-Leonard, Claronstat, Thorlondson, Weston, Beadrite, Universal Mikes, Centralab, Aerovox, Tohe, Yaxley, IRC, Dayrad, Hickok instruments, Supreme, Stancor replacement power transformer, condenser block, cone replacement, field coils and other manufacturers. Write for prices, 20% with order. M.O. acceptable. Include postage.

MAURICE SCHWARTZ & SON
710-712 BROADWAY SCHEENSTADY, N. Y.

UNIVERSAL BATTERY CONVERTERS

Maximum efficiency for amplifier and public address work or most any device requiring 110 A.C. (except radio receivers). Send for descriptive Circular. 40 watt-battery drain by at 1 1/2 amps.
110 Volt Alternating Current from 6 Volt Storage Batteries
List \$36.00. 1.50 watt-lattery drain at 18 amps.
List \$60.00 (Standard Discounts)



UNIVERSAL MICROPHONE CO., LTD.
424 Warren Lane,
Inglewood, Calif., U.S.A.

(1) Operation of Channel No. 1 Only (for 26 W. A.F. Output) from 110 V. A.C. Insert plug P1 in Socket S1. (plug P2 may be left inserted in its socket S2 and still only deliver 26 W. audio output providing Sw.2 is in the OFF position). Plug P2 is removed from socket S2 only when it is not desired to keep the second-channel tubes heated and plate voltage flowing.

(2) Operation of Channels Nos. 1 and 2 (for 52 W. A.F. Output) from 110 V. A.C. Insert plugs P1 and P2 in their respective sockets, S1 and S2. This provides filament and plate supply voltages to all the tubes in both channels.

(3) Operation of Channel No. 1 (for 26 W. A.F. Output) from One 6 V. Storage-Battery-Operated Motor-Generator. Insert plug P1 in the socket located on the base upon which the motor-generator is mounted.

(4) Operation of Channels Nos. 1 and 2 (for 52 W. A.F. Output) from Two 6 V. Storage-Battery-Operated Motor-Generators. Insert plugs P1 and P2 in the sockets of the two motor-generator units.

Option of Single- or Dual-Channel Operation

The amplifier output is matched by one output transformer and two or more loud-speakers. Inasmuch as the output of each amplifier channel is separately connected to its own multi-tapped output transformer, T2 and T4, respectively, it is possible to employ two separate and remotely placed banks of speakers. This arrangement provides for the operation of a cluster or group of speakers in a large auditorium, while another bank of speakers, operating from the second channel, may be placed outdoors to take care of overflow meetings.

The second-channel selector switch, Sw.1, eliminates the necessity of disconnecting speakers, or rearranging output impedance if only one group of reproducers is to be operated. By snapping this switch to the OFF position, the entire second channel and its associated bank of speakers are disconnected from the audio circuit without changing the output impedance relationship of the first channel to its group of reproducers. The 52 W. output of the combined channels may be fed into one or more reproducers operating simultaneously, by connecting output transformers T2 and T4 in parallel. (Be sure to "phase" the reproducers; the procedure has been described in past issues of RADIO-CRAFT.—Technical Editor)

Input and Output Facilities

It is suggested that external input matching transformers be employed to avoid hum being induced into the input circuit, particularly when the input matching transformer is placed too close to the magnetic flux of the power transformer, PT. It is specifically recommended that the operator employ the input mixer-fader control box described in the October, 1933 issue of RADIO-CRAFT. The output of each channel is available by means of two vertical rows of binding posts. Although there are actually available nine output impedances on each output transformer, you connect only five of these windings to each pair of output posts, reserving the sixth post in each instance for a common ground connection. The rest of the unused secondary taps should be carefully taped; they are provided for future requirements. Be sure to ground the chassis at input post 1P2.

The tremendous power produced by this amplifier in no manner makes the operation any more difficult than the control of any considerably less powerful amplifier—actually, any novice can operate this amplifier successfully—the controls are limited to the following: (1) a conventional volume and gain control V1; (2) a tone control V2; (3) the ON-OFF switch Sw.1; (4) the channel-selector switch, Sw.2; (5) and the two channel-plugs, P1 and P2.

No special, previous amplifier construction knowledge is necessary for those readers who shall decide to construct this amplifier. All necessary information is covered in this article. The author will be pleased to answer all correspondence in reference to this P.A. system which, incidentally, is available both in kit form and completely factory wired.

SERVICEMEN RADIO DEALERS



SEND FOR THIS

**FREE
CATALOG!**

IT'S CHOCK-FULL

of BARGAINS FOR YOU

Radio Dealers and Servicemen can't afford to be without this book. It offers marvelous buys in Radio Sets, Long and Short Wave Apparatus, Servicemen's Repair and Replacement Parts, Electrical Goods, Sporting Goods.

Just Off The Press!

Be among the first to have the pick of great bargains. Mail this coupon now!

RADIO CIRCULAR CO., INC.
225 Varick Street
New York, N. Y.

Dept. RC-234

Please send me free of charge and without obligation, your latest catalog.

Name
Address
City..... State.....

Here's a Book every Radio Man will refer to dozens of times every day--



A Valuable RADIO BOOK!

HERE is one radio book that answers every conceivable question on interference. It contains 76 pages, 8 1/2 x 11 inches, chock full with wiring diagrams, drawings and photographs showing where interference originates—how it is distributed, and how to eliminate it. This is a wealth of information needed by every radio listener, dealer and Service Man. Send fifty cents in stamps or check for this book.

RADIO-CRAFT MAGAZINE
96-98 Park Place New York, N. Y.

List of Parts

- One Coast-to-Coast class B power transformer, 350-350 V., 225 ma., No. PT 911, PT;
 - Two Coast-to-Coast filter chokes, 30 hy., 35 ma., 500 ohms, Ch.1, Ch.3;
 - Two Coast-to-Coast filter chokes, 20 hy., 150 ma., 100 ohms, Ch.2, Ch.4;
 - Two Coast-to-Coast class B input transformers, No. T1E911, T1, T3;
 - Two Coast-to-Coast class B output transformers, No. T2E911, T2, T4;
 - Two CRL potentiometers (Volume control), 1/2-meg., R22, R23;
 - Six Lynch resistors, 10,000 ohms. 1 W., R1, R4, R9, R10, R11 and R12;
 - Two Lynch resistors, 1/10-meg., 1 W., R2, R5;
 - Two Lynch resistors, 20,000 ohms. 1 W., R3, R6;
 - Three Lynch resistors, 1/4-meg., 1 W., R7, R18, R19;
 - Two Lynch resistors, 1,050 ohms. 1 W., R8, R15;
 - Three Lynch resistors, 0.4-ohm, 3 W., R13, R16, R17;
 - One Lynch resistor, 1/2-meg., R14;
 - Two Lynch resistors, 1000 ohms, 2 W., R20, R21;
 - Two Solar electrolytic condensers, 5 mf., 35 V., C1, C4;
 - One Solar electrolytic condenser, 4 mf., 500 V., C2;
 - Two Solar condensers, .05-mf., 400 V., C3, C6;
 - One Solar condenser, .02-mf., C7;
 - Two Solar electrolytic condensers, 10 mf., 75 V., C8, C11;
 - Three Solar electrolytic condensers, 3 x 8 mf., 500 V., C9, C10, C13;
 - One Solar electrolytic condenser, 4 mf., 500 V., C5;
 - One Solar electrolytic condenser, 8 mf., 500 V., C12;
 - Two cables and plugs, 2 ft. 5-wire;
 - One Coast-to-Coast drilled chassis 18 x 10 x 3 ins. high;
 - One assortment of necessary hardware, sockets, switches, etc.;
 - One set of RCA tubes, two 37's, two 59's, four 53's, one 83.
- OPTIONAL ACCESSORY**
- Two Remington 6 V. motor-generators to deliver 320 V., 110 ma., each.

INFORMATION BUREAU

(Continued from page 484)

(Q.) Can a vacuum tube voltmeter be used as a universal range ohmmeter? According to various articles in radio magazines I am lead to believe that it can: is this correct? If so, will you please show me how this can be accomplished and also the limits that this device can reach.

I have read many articles on the V.T. voltmeter but still do not understand how it can be used in radio servicing.

(A.) A vacuum tube voltmeter of the type that you desire was described in the article mentioned in answer to the previous question (RADIO-CRAFT, February, 1932). Details showing how it may be used have been described in other past issues (RADIO-CRAFT, May, June, August 1932 and January, 1933).

For a description of a good universal range ohmmeter, we suggest that you consult RADIO-CRAFT, July 1932, page 22.

POLICE ULTRA-HIGH-FREQUENCY SET

(238) Mr. Percy Willoughby, Chicago, Ill. (Q.) I have just heard about a new receiver that RCA-Victor is introducing for police radio use on ultra-high frequencies. I understand that this set is unusual in its design, having many novel features. As I am interested in ultra-short-wave reception, I will appreciate seeing the circuit and any available information covering this receiver. I believe the model number is AR-5006.

(A.) You are quite right, Mr. Willoughby, in saying that this set is an interesting one.

We are printing the circuit diagram with the values of many of the parts, on this page (Fig. Q.238) for your information. The set is designed for automobile use, and is made extremely rugged—mechanical simplicity and

Service Men! Can You Afford Not To Sell National Union Tubes?

LOOK!



ACT!

FREE EQUIPMENT—Although subject to withdrawal without notice, the items listed below are given free with National Union tube purchases. Small deposit. The alert dealer knows that equipment obtained this way has both the guarantee of the manufacturer and the backing of National Union. What do you need?

- Supreme No. 333 Analyzer
- Hickok Simplex Tube Tester
- Service Manuals—Auto Manual
- Triplet Oscillator and Output Meter
- Triplet Tube Tester

PROFIT—The 10% higher list price of National Union tubes enables the service man to make the highest margin of profit on his sales.

STANDARD PRICES—National Union tubes sold everywhere at full list price means the serviceman need not fear ill-will of customers who might otherwise see the tubes in "cut price" stores.

QUALITY—Strict adherence to closer manufacturing limits makes National Union tubes consistently superior. They are fully guaranteed. Continued customer satisfaction is assured.

OTHERS SAY—"... Found National Union tubes have stood up with all tests and requirements as advertised."

NATIONAL UNION JOBBERS STOCKS ARE COMPLETE

National Union Tubes Are Sold by More Servicemen Than Any Other Make!

SERVICE AIDS—SALE AIDS

For more than three years, National Union has specialized in service aids—such as Peak Frequency Charts, Tube Base Connection Finders, Voltage Divider Charts, etc., etc. These valuable aids available at no cost cannot be duplicated from any other single source. Every National Union service outlet can testify to what this has meant to him in better service work and more profit. National Union also provides sales aids, such as Post Cards, Radio Logs, Displays, etc., etc.

Investigate profit possibilities in amazing new Lederer Ultra Violet Lamp equipment!

National Union Radio Corporation of N. Y.
400 Madison Ave., New York, N. Y.

Send me details about your offer for:

NAME

STREET

CITYSTATE



RC2

HEADQUARTERS FOR PUBLIC ADDRESS AMPLIFIERS

BUY DIRECT from MANUFACTURER and SAVE BIG MONEY!

52 WATT AMPLIFIER Dual-Channel Dual-Output

Operates from either 110 Volts A.C. or from a 6 Volt Storage Battery—OR FROM BOTH!
Consumes 150 Watts! Set of 9 R.C.A. Tubes Cost Only \$8.91!

Nowhere in the Public Address Field can you duplicate the tremendous power, superb quality, ease of operation, extreme compactness (18" x 10" x 9"), light weight (51 lbs.), and the unusual versatility offered by this Amplifier which may be used for Sound Truck work as well as for portable or permanent installations to cover the largest indoor or outdoor assemblages.

Get the facts about this remarkable amplifier before you purchase your P.A. Equipment.
WRITE TODAY for our UNHEARD OF LOW PRICES! You will be amazed at the amount you save by buying Direct from the Manufacturer!

\$52 Completely Wired, Less Tubes
Also Available in Kit Form

COAST-TO-COAST-RADIO-CORP.
123 K-WEST 17TH STREET, NEW YORK, N.Y.

BIRNBACH Standoffs

Quality Insulators for careful amateurs. Compact; rugged; efficient. Pure porcelain, highly glazed. Nickel-plated brass hardware.

All standard types—also new feed-through models (plain or Jack) with porcelain insulating collar for metal-panel mounting. Write for Bulletin "B".

BIRNBACH RADIO CO., INC.
145 Hudson St., N.Y.C.

"KEY KLIX" IS OUT

Thousands of amateur radio items at the lowest prices are contained in this immense FREE book, together with many interesting articles by people well known in amateur radio circles.

GET YOUR COPY NOW

AMERICAN SALES COMPANY
Wholesale Radio Distributors
RC-44, W. 18th Street New York, N. Y.
The Oldest "HAM" Supply House
Established 1919

SERVICEMEN!

HERE'S HELP FOR YOU!

— Write today for your free copy of the prospectus outlining PRACTICAL MECHANICS OF RADIO SERVICE—a helpful new ADVANCED TRAINING system in 28 lessons by F. L. Sprayberry. Far from being for beginners, it has been prepared to help active servicemen keep abreast of the latest methods, make more money, do better and quicker work—land the best jobs.

WHAT \$10 WILL MEAN TO YOUR BUSINESS

Every type of servicing is covered fully in easily understandable style. From set testing with analyzers to the complex point-to-point method, nothing has been overlooked. Lessons cover super-hot circuits, A.V.C., public address, auto radio, etc., etc. Practical methods of testing condensers, transformers, tubes, etc., are detailed—latest developments analyzed—radio troubles discussed and their elimination explained. Another section deals with new tubes. Another describes analyzers and explains how to modernize all types for testing any circuit.

Here in one compact course, you have ALL the "done." You save hours of reading in scattered sources—you save time and money by being able to do jobs easier and quicker. Instead of following competition, make competition follow you!

WRITE FOR DETAILS—KEEP UP WITH THE TIMES!

F. L. SPRAYBERRY 132 Bryant St. N.W., Washington, D. C.

Please rush—FREE—complete details of PRACTICAL MECHANICS OF RADIO SERVICE—your new ADVANCED TRAINING system for servicemen.

Name RC-2
Address
City State

Give SERVICE

... with a Small Inventory

Here is the best Volume Control Proposition on the Market. Here are the reasons why?

1. Over 400 "exact duplicate" controls in the "X" series.
2. Yet with SIX controls in the original-AD-A-SWITCH-SERIES 477 sets can be serviced.
3. By combining controls in both lines any requirement can be met with minimum stock investment.
4. Clarostat with its two separate lines offers the widest range of controls to choose from.
5. Clarostat Controls are inseparable from Quality Service Work.

Clarostat "X" line has over 400 controls to choose from—exact as to electrical overall resistance, taper, bushing, shaft length, and will fit into exact space in set.

Clarostat Ad-A-Switch line comprises the maximum utility with minimum stock investment. Series W (Wire Wound) obtainable from 50 to 50,000 ohms. Series C (new composition element) obtainable from 10,000 to 5,000,000 ohms. Both lines obtainable in all tapers—insulated shaft 1 1/2" long. Wide use is indicated as follows: W-28 will service 128 sets; C-28 will service 108 sets; W-29, 77 sets; C-59, 66 sets; etc., etc.



NEW CONTROL REPLACEMENT GUIDE ON REQUEST

CLAROSTAT MFG. CO., INC.
287 North 6th Street, Brooklyn, N. Y.
AD-A-SWITCH was originated by Clarostat.

2nd EDITION
OFFICIAL PUBLIC ADDRESS AMPLIFIER MANUAL
AND SOUND SYSTEM TREATISE
THE ONLY BOOK AVAILABLE OF ITS KIND!
A Vital Necessity to Everyone Connected in Any Way With Sound Systems—Public Address Work—or Amplifiers.
Filled from cover to cover with real "meat"—no theories that are over your head—but full of practical "dope"—adequately illustrated, simply and clearly explained. Not only tells you WHY but shows you HOW to correctly install, test, operate, and maintain P.A. Systems. Written for Beginners, Dealers, Servicemen and Sound Engineers.
\$1.00 POST PAID
RADIO-AMP PUBLISHING CO.
123-R WEST 17th ST. NEW YORK CITY

high quality performance being keynotes in the design. It covers a band of 29 to 36 megacycles (8 to 10 meter band).

An examination of the circuit reveals that it is a super-regenerator—which is unusual for a commercial receiver. The set contains five tubes: a 78 as R.F. amplifier, a 37 as detector, a 37 as suppressor-frequency oscillator, a 37 as first A.F., and an 89 power pentode as second A.F.

Tuning is accomplished by small condensers connected across only a part of the tuning coils, with semi-adjustable condensers across the entire coil. In this way, the semi-variable condensers can be lined up for the desired frequency band. This will also align the tuning condensers (which work as band-spread tuning controls) which can then be tuned in the car to the exact frequency of the transmitter.

A 70,000 ohm resistor in the detector plate circuit controls the regeneration, which permits adjustment of the stability and sensitivity of the receiver.

The method of obtaining "IF" power from the car storage battery is novel. It will be noticed that it is a vibrator-type unit, which is an unusual method for use on ultra-high frequencies, where one would expect to find the noise level unusually high with this source of supply. However, the set is equipped with a series of chokes and bypass condensers that effectively prevent the disturbances from entering the susceptible parts of the receiver.

It will be noticed that the filtering of noise from the power supply unit has been carried to the point of isolating the filaments from their source of supply with R.F. chokes.

The receiver uses a dynamic reproducer with a low-resistance field coil which is activated directly from the storage battery.

The instructions for adjusting the receiver given by RCA-Victor are as follows:

With the receiver installed in the car, tuning dial set at 50, start in a location near the transmitter. Two adjustable trimmer capacitors are accessible through holes in the front of the receiver case: one at the left of the noise suppressor is the detector tuning adjustment (C5 in the diagram) and the other above and to the left of the loudspeaker is the R.F. tuning adjustment (C4 in the diagram). The sets as shipped have these trimmers adjusted for the 34.5 megacycle band; unscrew (decrease the capacity) these trimmers for higher frequencies and screw in (increase capacity) for lower frequencies.

First adjust C5 by the use of an insulated screwdriver until the signal is heard clearly. Keep the noise suppressor (marked regeneration control in the schematic) retarded until signal is fairly weak. Next, proceed with the car to a point where the signal is weak. Rotate the tuning dial to check the setting of 50 on the dial. At this point, with the aerial still disconnected, it will be possible to set the antenna stage to approximate resonance by adjusting C4 with the same screwdriver. Correct tuning will be noted by an increase in signal strength. Next connect the aerial and proceed to a point where the signal is again weak, and make final adjustments of C4, C5 and the noise suppressor.

The final setting of the noise suppressor should be made while completing the alignment, at the location where the weakest signal is received, with the car lights on, the car idling and with the volume control near maximum. Under these conditions the noise suppressor should be turned counter-clockwise until the signal-to-noise ratio is a maximum. In this case the receiver's usable sensitivity is a maximum. Clockwise rotation of the suppressor may produce a louder signal but it will bring up the noise still more. Further counter-clockwise rotation may cause a weak signal to be cut off, particularly when the battery is weak. (The dial scale covers a band of approximately two megacycles from the 0 position to 100.)

The following potentials are supplied to the various tubes:

Tube Type	K, to Grid, K, to S.-G, K, to P.	Volts	Volts	Volts	Ma.
R.F.	3,3	125	253	9.0	
Det.	0	—	10-35	0.5	
Sup. F. Osc.	2,5	—	30	2.5	
A.F.1	16,0	—	235	6.4	
A.F.2	26,0	230	217	25.0	

FREE!

Choice of One or More of These Popular Short Wave Books

Here's money put right into your pocket—here's a saving you never gave a thought to. You get absolutely FREE any one or more of the regular 25c and 50c short wave books with a year's subscription to SHORT WAVE CRAFT, the Radio Experimenter's Magazine. A one year's subscription brings you one fifty cent book or two twenty-five cent books; a two-year subscription brings you two fifty cent books and any one twenty-five cent book. Decide NOW what books are most necessary to you—then send us your subscription by return mail. The books will be sent to you immediately.

25¢ The Copy



On All Newsstands

4-Color Cover
9" x 12" in Size
Over 200 Illustrations



No. 1 50c No. 2 50c No. 3 25c No. 4 25c

THIS popular short-wave magazine interests the great army of "hams," broadcast listeners, and general radio students who are interested in experimental as well as scientific angles of short wave development and application. In each monthly issue appears the latest and most correct short-wave station call list, and important construction articles on receivers and transmitters, including "picture" diagrams easily understood by anyone, a big feature "originated" by SHORT WAVE CRAFT. You'll also find the latest news about short-wave physics, micro- and ultra-short waves and other applications of this newest branch of radio.

Many Short Wave Sets to Build

Many excellent short-wave sets with complete construction details with "picture" diagrams, are found in every issue—these sets vary from simple one- and two-tube sets to those of more advanced design, five and eight tubes.

Big Silver Trophy FREE!

Recently inaugurated by Mr. Hugo Gernsback, Editor, was the "Short Wave Scout Contest." To the Short-Wave "fan" who has logged and obtained verification of the largest number of short-wave stations from all over the world, during one month, will be awarded a magnificent silver Short Wave Scout Trophy.

Mail This Coupon Today!

SHORT WAVE CRAFT, Dept. RC-234
96-98 Park Place, New York, N. Y.
Gentlemen: Enclosed you will find my remittance for a subscription to SHORT WAVE CRAFT for
[] One Year @ \$2.50 (Canadian and foreign \$3.00)
[] Two Years @ \$5.00 (Canadian and foreign \$6.00)
Send me FREE books which are circled below.

Name
Address
City State

(Send remittance in check or money order. Register letter if it contains cash or unused U. S. Postage Stamps.)

SERVICEMEN

Why be handicapped with an ancient analyzer when in two hours you can easily modernize it with one of these kits and a pair of composite sockets! Directions and diagrams included with all outfits



Here is the professional model. Used on the latest Weston-Jewell, Hickok, Supreme, etc. testers. If you want the best get this kit. Has the famous Na-Aid Latch-Lock with thumb release.

907WLA New small 7-prong Latch-Lock Analyzer Plug List with Twin C.G. Handle. \$3.50

974D8A 7A to 4-prong Latch Adapter 1.25

975D8A 7A to 5-prong Latch Adapter 1.25

976D8A 7A to 6-prong Latch Adapter 1.25

977D8A 7A to 7-prong Latch Adapter 1.25

907WLA KIT Complete as shown \$8.50



Here is the set for those who want the lowest possible cost. Does not have means for locking the adapters to the plug but is serviceable in every way. The wired adapters having the necessary small base for fitting shielded sockets. C. G. stud supplied.

977P 7-prong Plain-Type Analyzer Plug \$.40

974W 7 to 4-prong Wired Adapter55

975W 7 to 5-prong Wired Adapter55

976W 7 to 6-prong Wired Adapter55

977WA 7 to 7A-prong Adapter55

977P KIT Complete as shown \$2.60

8-Wire Braid-Covered Analyzer Cable. List 10c. ft. 4-5-6 Contact Composite Socket. List 50c ea. 477 Contact Composite Socket. List 50c ea.

It's here at last!—The "Make-Your-Own" Adapter Kit. All the parts for making any required adapter, including all ten types of socket top-sections and small sized base-sections complete with over two dozen assorted extension, soldering, connecting, control and control-grid terminals, connectors, clips and lead wires. 900 "Make-Your-Own" Adapter Kit complete. List \$2.50. Bought separately each 4, 5, 6, 7 and small top or base section lists at 25c each.

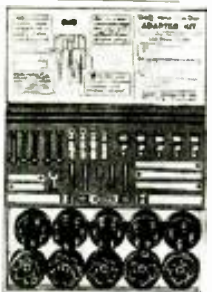

HERE'S HOW TO MODERNIZE YOUR CHECKER



List \$6 950Xyla Checks over 120 new tubes including small 7's in your present tube checker. If checker has no fil. voltage switch, adapter 954SGL. List \$1.25 is also required. Servicemen's discount 35%; on orders listing at \$10 or more, 40%.

List \$6 950TR Checks ALL 16 to 30 volt filament tubes in the 21 tube checker socket with 2 1/2 volts. Has filament voltage selector switch and internal transformer.

HERE'S THE DATA YOU WANT

Send two 3c stamps for new 16 page Booklet showing illustrated tube socket connections of 268 different tubes, data and diagrams on rewiring any obsolete set analyzer or tube checker and information on using the new tubes in place of old types. Includes catalog pages on all kinds of sockets, speaker plugs, connectors, wound and unwound coil forms, coil winding data, S-W receiver references, etc.

ALDEN PRODUCTS CO.
Dept. R-2, 715 Center St.
BROCKTON, MASS.

TRIPLET Meters

No. 1167 Free Point Set Analyzer

Our Net Price \$25, less 2%.

Discount for Cash

We carry the complete line. Call or write for descriptive bulletin.



45D VESEY STREET New York, N. Y.

WLW ON THE AIR WITH 500 KW.

(Continued from page 457)

Crosley's "5 Year Plan"

In commenting on the new station, Joseph A. Chambers, technical supervisor of the station, says:

"The Crosley Radio Corporation has always pioneered in radio broadcasting; its WLW having been the first station in each successive increase in power and the first to put many new ideas into practice.

"We have been working toward this world's largest 0.5-megawatt transmitter for the past five years and our own technical staff worked up complete plans for such a unit, even though many people told us it could not be done. About a year ago we submitted our plans and predictions to the Federal Radio Commission. They became very much interested and decided to allow us to construct such a transmitter.

"Then came a series of meetings with many of the country's best radio engineers. Since it was an experimental transmitter of entirely new design, it rapidly developed into an engineers' picnic. It was decided to incorporate as many new and radical ideas as possible and for this reason it was necessary to design many new pieces of equipment. I am sure it is going to be the last word in broadcast transmitter design and will incorporate many features never before attempted.

"Briefly, the new equipment is an R.F. amplifier capable of 2,000,000 W. (2 megawatts) peak output; an A.F. amplifier of sufficient size to modulate the R.F. amplifier; and the necessary power supply and control circuits.

The R.F. Amplifier

"The R.F. amplifier contains twelve type 8G2, 100 kw. tubes. These are divided into three units of four tubes each, in each of which the tubes are operated in parallel push-push combinations. Each unit has its own grid-tank and plate-tank circuits. This arrangement, along with unusual mechanical design, results in a very stable amplifier. Each unit is individually neutralized, with the tubes operating as class C amplifiers. The final A.F. stage or modulator contains eight 100 kw. tubes. These are divided into two units of four tubes each. They are also operated in parallel push-push as class B amplifiers. The output A.F. transformer is divided into two sections; there is one section for each of the modulator units. The secondaries of the two sections are connected in series and the output modulates the plate voltage of the final R.F. amplifier. Direct current is blocked out of the modulation transformer secondaries and a 500 mf. audio coupling condenser is used. This amplifier is capable of delivering over 400 kw. of undistorted power output.

The Power Supply

"Filament and bias power is supplied by motor-generators; 4,300 A. at 225 V., for the filaments, is delivered by three 1,500 A. generators connected in parallel. They are driven by three 75 h.p., 2,300 V. motors. These motor-generators can be controlled individually or as a unit. Normally, they are controlled as a unit from the console on the transmitter floor, and a single control adjusts the voltage from all three generators. Naturally, the generators are of special design to have minimum ripple and other desirable characteristics.

The main plate supply rectifier will deliver 100 A. at 12,000 V. This is the normal voltage applied to all the tubes. At 100 per cent modulation, the peak voltage applied to the R.F. stages will be 24,000 V. A three-phase full-wave rectifier circuit is used, employing 6 special, type 870 hot-cathode mercury-vapor rectifier tubes.

A system of oil-immersed switches controlled from the control console on the transmitter floor permits the rectifier transformer primaries to be connected either in Delta or Y formation. This permits two voltages, namely 8,000 and 12,000 V. as normal operating voltages. Automatic step starting is also afforded whereby the voltage is applied gradually.

Make Quicker, More Accurate Tests



with this NEW No. 1167

TRIPLET Instrument



DEVELOPED by some of the industry's outstanding engineers, the new Triplett No. 1167 instrument is arousing widespread interest. While simply designed and easily operated, its extreme accuracy and completeness satisfy the most exacting requirements of the professional service man.

With this new instrument, you can quickly and accurately measure voltages, current, resistances and continuities without removing the chassis from the cabinet . . . using the cable and plug to make the connections between the set socket and the tester.

The 1167 unit incorporates a direct-reading Ohmmeter, Output Meter, AC-DC Voltmeter and a Milliammeter. All readings are controlled by a selector switch. The single meter has 1000 ohms per volt resistance. Voltage readings range from 0 to 750—Milliampere readings from 0 to 150—Ohmmeter readings from 0 to 3,000,000.

Four sockets take care of all tubes now in use. These sockets can be easily and economically replaced whenever other sockets with added connections are required. It is no longer necessary to carry additional cables, plus, etc.

YOUR JOBBER CAN SUPPLY YOU

. . . at the dealer's net price of \$25.00

The TRIPLET ELECTRICAL INSTRUMENT COMPANY

35 Main Street

Bluffton, Ohio

MAIL TODAY FOR DETAILS

THE TRIPLET ELECTRICAL INSTRUMENT CO., 35 Main St., Bluffton, Ohio.

Gentlemen:

Send me catalog on Triplett Instrument No. 1167, and your complete line of radio servicing instruments.

Name

Street Address

City..... State.....

Just Hear Those "Foreigners" Roll in
on the 1934 POSTAL "All-Wave"
INTERNATIONAL

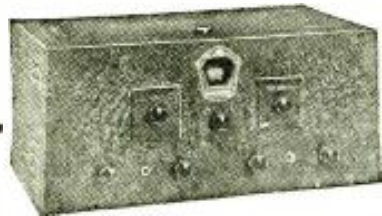

The INTERNATIONAL "All-Wave" 9-Tube Superheterodyne Receiver.

Here's the short-wave receiver made famous by Captain Horace L. Hall—it's the set on which he has pulled in those hard to get foreign stations, on the loudspeaker, with clarity and plenty of volume. It's the set that every DX fan should use in tuning foreign broadcasts to make them sound like local. It's the set you must test in your home to enjoy the difference between just a regular short-wave set and the Postal "All-Wave" INTERNATIONAL.

IT'S THE NEW SHORT WAVE SENSATION

This custom-built, professional, all-wave receiver is for amateurs, short-wave fans or professional DXers. It employs a tuned R.F. preselector, with new triple draw coils and instantaneous 180 degrees band spread. It also features a 1-W heat oscillator, electron coupled oscillator phone jack 3 watt output, and antenna trimmer. No extraneous harmonics or drifts.

The INTERNATIONAL is sold direct from our laboratory with a money back guarantee, for those who want an instrument of precision and quality and at a new low price for a genuine professional custom-built receiver. Send for stamp for schematic diagram and circular that illustrates and describes the POSTAL INTERNATIONAL and the special offer to Radio-Craft Readers.

POSTAL RADIO 135K Liberty St. New York, N. Y.

**STEWART-WARNER
FACTORY CO-OPERATION
FOR SERVICE MEN**

Service meetings will be held all over the country by special factory radio field engineers. Complete diagram talk on new as well as old Stewart-Warner circuits will show you the easy way to service Stewart Warner radio sets. Service manuals on all new Home and Auto Sets will be given free.

For time and place of meeting, write

Service Department
STEWART-WARNER CORP.
1826 Diversy Parkway - - Chicago

**PRACTICAL
RADIO ENGINEERING**

An opportunity for RADIO MEN to enlarge their scope of training.

Whether elementary radio principles or advanced subjects, sound applications or practical radio engineering, RCA Institutes is prepared to give you the instruction you need.



RESIDENT SCHOOLS NEW YORK AND CHICAGO with modern standard equipment

EXTENSION COURSES FOR HOME STUDY under convenient "no obligation" plan. Illustrated Catalog on Request

RCA INSTITUTES, INC.

Dept. RT-2
75 Varick Street, New York
1134 Merchandise Mart, Chicago

FREE 1934 RADIO CATALOG
BARGAINS GALORE FOR DEALERS — SERVICEMEN — AMATEURS
Important News for Radio Men: HANDY SERVICE MANUAL
128 Pages of Important Information Regularly \$1.00 For Limited Time Only **25c**
TRY-MO RADIO CO., Inc.
85 CORTLANDT ST., Dept. C-2 NEW YORK CITY

"Probably the outstanding feature of the entire installation is that high-level modulation is used and that class B A.F. amplifiers deliver the required audio power.

"This has various advantages particularly in that it permits more economical use of power. All R.F. stages are operated in class C, which as you know is the most stable and efficient R.F. amplifier.

Class B A.F. Amplifier

"The A.F. amplifiers, consuming large amounts of power, are operated in class B, which is the most efficient A.F. amplifier. Fortunately, the 100 kw. tube is excellent as a class B audio amplifier and high quality A.F. amplification is obtained. The largest single problem was the design and construction of the tremendous A.F. transformers used as modulation transformers.

"Some interesting problems resulted from this high-power class B amplification. Power is drawn by the modulators in "gobs" at syllabic frequencies; in other words, very low power between words and high power at peaks of modulation. This means that in order that the voltage may remain constant under the highly variable load, the entire power supply system must have very low reactance. A 250 mf. filter condenser is used in the main rectifier filter. The rectifier transformers are special, having low reactance values. Special lines to our transmitter have been installed to meet our load conditions.

"In view of the fact that all the power equipment is of the low-reactance type, this reactance cannot be counted upon for any protection in case of short-circuits or rectifier-tube flashbacks. Almost unlimited power would be fed into any fault. To supply the necessary protection under these conditions and also to meet various other control requirements, a special, high-speed circuit breaker was developed as rectifier primary control. This breaker is rated at 100,000 A. interrupting capacity and is so fixed that the time from the energizing of the trip coil until the arc is extinguished is only 1/12-second. It closes just as fast and the transmitter control circuits are so arranged that under certain conditions this breaker may open three times under short-circuit conditions in less than a second.

Introducing the "Concentric" Transmission Line

"The output of the R.F. amplifier is transmitted to the antenna proper by a "concentric" type of transmission line. This type of transmission line has not before been used for broadcasting and its use, particularly at 500 kw., involved quite a few problems. The transmission line was designed after the tower had been completed and measured, and was designed to match the tower impedance without the necessity of any coupling system whatsoever. This eliminated quite a bit of equipment with corresponding losses and harmonic radiation. The particular advantage of the concentric type transmission line is the reduction of harmonic radiation, which represents quite a problem with 500,000 W. power.

A 136 Ton "Tower-Antenna"

"The tower itself is quite an engineering accomplishment. It stands 830 ft. above the surface of the ground and its foundation extends 70 ft. beneath the ground. After work had been started on the foundation, it was found that beginning at 30 ft. and going down, the soil was soft blue clay. It was necessary for us to change the design of the foundation and we drove 24 wood piles as the main bearing.

"The steel itself weighs 136 tons. This weight, combined with the downpull of the eight guy wires makes a total load on the base insulator of about 450 tons. The base insulator is made up of two apparently fragile porcelain cones so connected in the middle that swaying of the tower will not put any twisting forces in the porcelain. As long as most of the load is direct compression this insulator will stand up to about 1,500 tons.

"This insulator and the guy wire insulators were necessary to insulate the tower from ground. The reason for this is that the tower itself is used as the antenna. The signals actually radiate from the tower structure (Radio-Craft, November 1931, page 269). Fifty-six insulators were used in the

SURPLUS RADIO PRODUCTS

ORDER DIRECT FROM THIS ADVERTISEMENT—WE DO NOT ISSUE ANY CATALOG

WE HAVE ON HAND

197 JENSEN Auditorium Speakers

CONE SIZE 13 1/2 INCHES

MODEL D-7 D. C. Dynamic

LIST PRICE \$45.00

NET TO YOU

\$9.95



Especially Suited for THEATRE, PUBLIC ADDRESS, OUTDOOR ANNOUNCING

Handling Amplifiers Delivering 20 Watts 2500 Ohm field

Push-Pull 247 Output Transformer Shipping Weight 20 lbs.

WE HAVE ON HAND

95 Westinghouse

Power Generator

MANUFACTURED FOR U. S. GOVERNMENT \$75.00 VALUE



Manufactured by Westinghouse for the U. S. Signal Corps, the sturdy construction of this instrument recommends it to the technician.

Built-in commutator takes off the generated D.C. Three leads extend through the casing to permit a 4 1/2 V. flashlight-type battery to be switched into circuit for starting, and to control the A.C. output of the generator. Rotated at its normal speed of 4,500 r.p.m., the output is 200 W., at 115 to 125 V. (on open circuit), 900 cycles.

The rotor turns in ball bearings. Shaft length (driving end), 2 ins.; diameter 9/16-in.; the end is threaded for a distance of 3/8-in. Case dimensions exclusive of the shaft, 4 1/2 x 6 1/4 in. in diameter. Guaranteed new and perfect. Worth \$75.00, but while they last, only \$4.95, plus shipping charges. Shipping weight 13 lbs.

REMIT BY CHECK OR MONEY ORDER FOR FULL AMOUNT OF EACH ITEM—SHIPPED EXPRESS COLLECT. NO C. O. D. ORDER ACCEPTED—MONEY REFUNDED IF NOT SATISFIED.

Wellworth Trading Company 111 West Lake Street, Chicago, Ill. RC-234

Enclosed you will find my remittance of \$..... for which please send me by Express Collect:

- () Jensen 13 1/2" Auditorium Speaker, \$9.95 each
- () Power Generator, \$4.95 each

Name
Address
City..... State.....

guy wires to insulate the tower from ground and to break up the guy wires so that they could not distort the pattern. All eight guy wires fasten to the tower near the center at which point the tower is 35 ft. across.

"By actual measurement the use of this antenna with the previous 50 kw. transmitter resulted in an average improvement of 40 per cent in signal strength and in most cases eliminated "distortion" fading as well as moving the primary fading zone out about 50 per cent.

Summary of Features

"To summarize some of the outstanding features of the transmitter I want to point out:

(1) The normal carrier delivered to the antenna is 0.5-megawatt (500,000 watts).

(2) 100 per cent modulation of this 0.5-megawatt is obtained.

(3) This means that 2 megawatts of power is radiated at peaks of modulation.

(4) An average of 1,800 kva. of power is required.

(5) The frequency characteristic of the entire transmitter is flat (within 2 db.) from 30 to 10,000 cycles.

(6) The total A.F. harmonics do not exceed 10 per cent up to 95 per cent modulation.

(7) The R.F. harmonic radiation is so low that at any point the harmonics will not be greater than 1/100 of one per cent of the fundamental.

(8) Rectifier filaments which require 30 minutes to heat up are turned on by a time clock; spare tubes are kept hot at all times.

(9) The starting control system will start the entire transmitter automatically in proper sequence and with proper time delays, if desired; or individual control of any part of the sequence may be obtained by switches on the control console.

(10) In case of momentary failures such as arc-overs or tube flash which can be cleared by removal of power, the transmitter is automatically re-started in about 1/5-second.

(11) In cases of failure requiring attention the unit containing the failure is automatically isolated and the transmitter automatically re-started in about one second and continues operating at slightly reduced power. All dangerous voltages are removed from the isolated unit allowing engineers to get in and make repairs, and the unit can then be automatically reconnected in a fraction of a second.

(12) There are over 50 tons of A.F. transformers in the transmitter. The modulation transformers themselves weigh almost fifty tons and contain 1,400 gallons of oil. Of course, they are by far the largest in the world.

(13) A 550 mf. A.F. coupling condenser is used in the modulator.

(14) A 260 mf. filter condenser is used in the main plate supply.

(15) Air at the rate of 22,500 cubic ft. per minute is circulated for cooling various parts of the transmitter.

(16) For tube cooling, 500 gallons of distilled water and 700 gallons of city water are circulated each minute. A 75 x 75 ft. spray pond is used for cooling the city water so that it may be used over. This, in turn, is used for cooling the distilled water by means of a heat exchanger. On a hot summer day the makeup water required to make up for evaporation alone is 28,000 gallons a day.

(17) Class B A.F. amplification capable of delivering over 500 kw. of A.F. power is used for high-level modulation.

(18) A special concentric type transmission line is used to transmit the R.F. power from the transmitter to the antenna.

(19) A 0.58-wave vertical radiator, 830 ft. high is used as an antenna.

What Will Happen When Super-Power WLW Goes on the Air?

"As to the results of the 0.5-megawatt transmitter we can make the following predictions based on our previous studies.

"Considering power increase alone and ignoring for the moment the increased efficiency of the vertical radiator which has already been realized on the 50 kw. WLW transmitter, the signal strength of 500 kw. WLW will be 3 1/4 times as strong as previously. There-



The two Loudspeakers each 17 3/4 in. x 13 3/4 in. x 3 3/4 in. supplied with the PG-62-B equipment.

22 in. x 15 1/4 in. x 11 1/8 in. (closed) PG-62-B Carrying Case (open) containing Two Loudspeakers and Cables.



22 in. x 15 1/4 in. x 9 in. (closed) PG-62-B Amplifier Carrying Case, opened.



Velocity Microphone and Stand



Centralized Sound Section



RCA VICTOR Co. Inc. CAMDEN, NEW JERSEY "RADIO HEADQUARTERS"

RCA VICTOR

Portable Public Address System

Type PG-62-B

Type PG-62-B complete portable public address system, including the famous Velocity Microphone, a high grade Class B 20 watt amplifier and two modern dynamic loudspeakers with extension cords—all self-contained in two carrying cases. Operates on 110 volts AC, and is designed to reenforce speech and music. Provision for electrical phonograph input. Type PG-63 is a less expensive model, employing one loudspeaker and carbon type microphone, and is self-contained in one carrying case.

Write for descriptive folders

Portable electric phonograph units of single and double turn-table types available for either of the above equipments.



"MULTI-TAP" UNIVERSAL POWER TRANSFORMER

(Patent Applied For)

FIFTH UNIT

Renews original performance in case of transformer trouble in 149 models, makes of high powered radios, other than the 1377 models which can be handled by the 4 MULTI-TAP power units in the Service Engineers Emergency Stock. With these 5 units you can give immediate service on over 95% of radio power unit troubles.

ELECTRICAL CHARACTERISTICS OF FIFTH UNIT

No. 1881	Volts	Amps.
7-26, 1185	1.5V	7.35
7-21, 27, 37, 53, 59	2.5V	11.5
9-484, C185	3.0V	11.7
2-15, 36, 47, 59, 2A3, 2A5	2.5V	3.0
2-484, C485	3.0V	2.6
2-210, 250, C585, C586	1.5V	2.5
2-281, C281 in parallel	1.5V	2.5
or 2-281, C281 in series	15.0V	1.25
High Voltage	1400 v. c.t.	at 150 M A

FREE for the Asking!

General Bulletin No. 3 listing 1526 models of radios, in which one of the 5 Multi-tap universals can be used for replacing power transformer in trouble to restore original performance. Bulletin shows electrical characteristics, mounting dimensions, price, etc., of each unit, for 110 V., 60 cy., 220 V., 60 cy., and 110 V., 25-40 cy.

MAIL THIS COUPON TODAY

GENERAL TRANSFORMER CORP., 504 S. Throop St., Chicago.

Send me without charge General Bulletin No. 3 and address of nearest distributor where I can get Multi-tap Universal power units.

Name

Street

City

State

MILES SOCKET MIKE

(Pat. Pend. Developed by MILES)

A microphone which plugs into the light socket and which reproduces speech and music in your own radio from any place in building without wires. Clear, powerful, instantaneous reception at your disposal—anytime, anywhere. Details on request.

MILES SOCKET MIKE CO.

Dept. RC
244 WEST 23rd ST. NEW YORK, N. Y.
We repair any make microphone—quick delivery.

Complete Kit of Parts to Build the 5 Meter TRANSCIEVER

This low price is for parts used in the construction of the \$15.95 "Transceiver" only. Microphones, Phones, Tubes, Batteries and Battery Box can be furnished at correspondingly low prices.

BLAN, The Radio Man, Inc.
177C Greenwich St. New York, N. Y.

fore, wherever WLAW has been well received, the increase of 3 1/4 times will not be particularly noticeable as there will be no reference level and the receiver volume control will need to be reduced only slightly. However, where the WLAW signal was comparable to noise or static levels, the increase will permit satisfactory reception in spite of the noises. Although the signal strength at any given point is only increased 325 per cent, the area covered by a signal down to any predetermined value will be increased 1000 per cent, with a corresponding increase in our potential audience.

"Mr. Crosley has continually endeavored to provide radio programs particularly to the great number of people in small towns and rural communities which do not have a high-quality broadcast station close to them. With this in mind, we plan all of our efforts toward serving the greatest number of people and particularly those not served by local stations. In other words, we are placing a definite value on our secondary coverage. Very few stations are doing this and this fact is our justification for the increased power which we are now trying to get.

"To those who may be alarmed about local blanketing may I point out that the increased signal over the previous value is the same as the increase when we went to 50 kw. from 5 kw. There was considerable alarm at that time over the blanketing and as everyone found, it was not at all serious. In the meantime, receiver selectivity has been greatly improved and we expect even fewer complaints when we go from 50 kw. to 500 kw. than when we went from 5 kw. to 50 k. Another point to mention is that the signal strength over most of Cincinnati with 500 kw. will be in general less than the signal strength of WKRC now located in Walnut Hills! This, of course, is due to the difference in distance."

(The tendency toward higher and higher power in broadcasting transmitters is clearly shown by this new WLAW—we wonder how high the power will be increased before the apex is reached?—Associate Editor)

RADIO SHORT-CUTS

(Continued from page 488)

the stator and rotor plates in the same relative horizontal and vertical positions, when mounting.

This 2-gang midget (trimmer) condenser, C, Fig. 3A, can be mounted on the side of the big (gauged) tuning condenser, or directly behind the panel. Use a very small graduated dial (or, even a small knob with pointer arrow will answer the purpose).

Using a good oscillator, realign the R.F. and detector at 1,400 kc, by slightly decreasing the trimmer condensers (that is, the ones that were originally built-in at the factory).

IMPROVING THE "OLD" RADIOLAMP

F. T. Olivera

IN your May, 1933 issue of RADIO-CRAFT you have shown the construction of the so-called "Radiolamp," the design of which surely is novel.

However, by connecting an S.P.D.T. switch in place of the set switch, as shown in Fig. 4, the switch in the lamp socket may be used as the master switch both for the radio and lamp. This permits the lamp to be used alone when desired.

A.F. OSCILLATOR

Donald Slattery

I HAVE a circuit (Fig. 5) for an A.F. oscillator that gives a sine wave output. It is excellent for use on bridges in determining ionization constant, inductances, capacities, etc.

It is an excellent use for old audio transformers. The poorer the transformer, the better the results. By using high-grade transformers I have succeeded in producing waves as slow as one cycle every two seconds. The output is fairly large.

BOOK REVIEW

AIRCRAFT RADIO, by Myron F. Eddy. Published by The Ronald Press Co., New York, N. Y. First edition, 6 x 8 1/2 ins., 284 pages, 68 illustrations, cloth covers. Price, \$4.50.

This is the first book on this subject that we have had the pleasure of reading; it is an excellent volume, well prepared and covering the subject in a complete and concise manner.

Lieutenant Eddy, the author of the book, has spent years teaching radio in the naval aviation ground schools and later at commercial aviation schools.

The volume starts with a very useful introduction to the fundamentals of electricity, including the elementary principles of matter; electrons; currents; circuits and conductors. The vacuum tube and its use in radio receiving and transmitting circuits is explained fully and simply.

Following this is a detailed description of various types of radio telegraph and telephone transmitters used for aircraft work. Radio receivers and their associated equipment are given plenty of consideration, both in the long-wave and short-wave aspects.

One of the most promising functions of radio in aviation is the part it plays in navigation; that is, the use of radio beacons, radio markers, aural and visual range beacons, the deionometer and other similar instruments. Lieutenant Eddy's description of these units and their applications shows a clear and comprehensive understanding of their design, purpose and application.

Anyone who has installed radio sets in automobiles has a vague haking of the difficulties normally encountered in successfully installing radio equipment in airplanes. Chapter 8 in this book explains these difficulties and also includes a detailed description of the methods of overcoming them.

The final chapters of the book cover the government regulations pertaining to aircraft radio and a glossary of terms and symbols used in radio work.

Another Big Boom In Radio . . .

PUBLIC ADDRESS INSTALLATION

It's a Money-Making Field

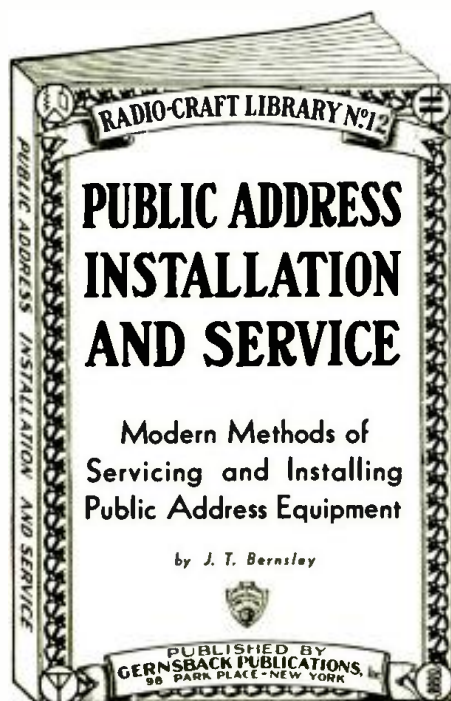

Here is a new edition to the RADIO-CRAFT Library Series—it's a book which shows radio men how to really make extra money in a fast-growing field, allied to radio. In public address work unlimited opportunities arise—it's practically a rejuvenation in radio. Know the facts about public address equipment and get your share of business. Get a copy of PUBLIC ADDRESS INSTALLATION AND SERVICING, by J. T. Bernsley—it covers modern methods of servicing and installing public address equipment.

A BRIEF SUMMARY OF THE CONTENTS

AUDIO AMPLIFIER FUNDAMENTALS—Introduction; Discussion on types of amplification—transformer coupling, resistor coupling, impedance coupling, push-pull and miscellaneous; New Terms and Theory—Class A amplification, Class B amplification, Voltage amplifier; Power amplification; Pre-amplifier, Carbon microphone, Condenser microphone, Ribbon or velocity microphone; Power Supply Requirements—For Class A; For Class B.

PUBLIC ADDRESS AMPLIFIERS—Standard Installation—1 1/2 watt amplifier, 7 watt amplifier, 10 watt amplifier, 15 watt amplifier, 20 watt amplifier, 30 watt amplifier, 40 watt amplifier, 50 watt amplifier; Special Installation—Portable—6 volt operated amplifier; Mobile-use amplifier, 20 watt (Radio-Craft), AC-DC and 6 volt amplifier, Pre-amplifier (1 stage, 2 stage, 3 stage).

INSTALLATION INSTRUCTION—Analyzing Requirements; Best methods for installing—Indoor, outdoor; Methods for minimizing "howl" or audio oscillation present after installing; Speaker installation (horn type, baffie type); General Instructions and Hints.

ACOUSTICS—How to survey and analyze an auditorium for reverberation time with formulas, and correct method for treatment; chart with absorption coefficients of standard treating material.

SERVICING—FORMULAS—Amplifiers; Power Supply devices; Speakers; Microphones; Carbon condenser, ribbon or velocity; Formulae decibel, meaning and use, calculation overall audio gain, distortion in amplifier; Conclusion.

64 PAGES — 6 x 9 INCHES — OVER 50 ILLUSTRATIONS

This book may be bought in combination with other books in the RADIO-CRAFT Library Series—see page 509 for complete details of the other books.

GERNSBACK PUBLICATIONS, Inc. 96-98 Park Place, New York, N. Y.

GERNSBACK PUBLICATIONS, Inc., 96-98 Park Place, New York, N. Y.
Gentlemen: Enclosed you will find 50 cents, stamps, checks or money order accepted, for which send me postage prepaid, One Copy of the new book, PUBLIC ADDRESS INSTALLATION AND SERVICING.

Name

Address

City

AIRPLANE RECEIVER AND 5 METER TRANSCEIVER

(Continued from page 497)

wired as shown in Fig. 2B). Note that the socket member of the separable connector is connected to the battery container. Thus, it is impossible to short-circuit the live terminals while handling the container at any stage of the transfer. The battery container was conveniently located in the pilot's compartment, while the remainder of the equipment, as illustrated, was located in the berth or rear compartment.

The rear of the sub-panel is supported by a bracket to prevent the tuning control from binding.

Initial tests of the apparatus indicated that the rigid mounting of the transceiver resulted in A.F. modulation at certain motor speeds which tended to break up the voice frequencies. The live-rubber mounting eventually selected to overcome this condition was somewhat of an improvement over the arrangement shown in Fig. B. The live-rubber strip was folded over a short piece of wood to form an inverted U. A second piece of wood was placed as a cleat across the live rubber and screwed to the woodwork of the airplane; the first piece of wood prevented the live rubber pulling out of position. The other end of the length of live rubber was terminated by a clamp which bit into the rubber and held the two ends of the U; a second cleat at this end of the length of rubber held the rubber in a stretched position. Two of these vertical lengths were used; it was then only necessary to drill through these vertical strips and bolt the transceiver to the live-rubber strips.

(Microphone springs proved quite suitable for mounting the transceiver in the refueling airplane.)

The range of this transceiver has not yet been determined; however, this type of instrument is capable of covering quite a distance, depending upon individual conditions; preliminary tests resulted in good telephone conversation over a distance of a few miles.

The circuit of this transceiver or combination transmitter and receiver is simple in the extreme. In fact, it in some respects presents but few fundamental new features, the basic circuit having appeared a number of times in QST magazine. Oscillator V1 generates the 56 megacycle or 5 meter signal which in the T. position of Sw.2 is modulated by the A.F. output of V2; at the same time, the headphones, plate coil, L5, and resistor R2, the bias resistor for V1, are short-circuited. In the receiving position R. V2 becomes effective as a generator of a super-audible frequency which is then superimposed on the circuit of V1, thus producing the super-sensitive super-regenerative receiving circuit with which the readers of RADIO-CRAFT are familiar (RADIO-CRAFT, August 1931, page 90, and October 1931, page 222).

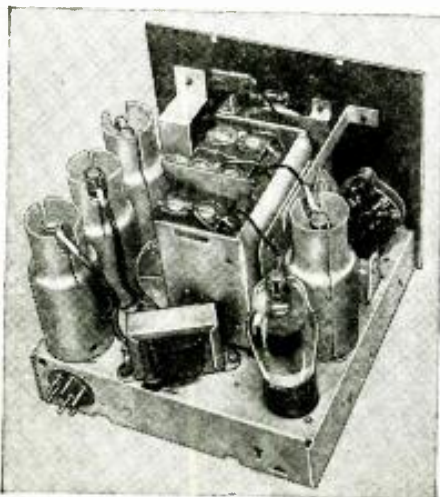

Fig. F

The interior of the dual-range receiver.

The rushing sound normal to super-regenerative operation disappears when the transmitting station is tuned in. A tiny adjustment on either side of the correct position results in distorted reproduction and greatly reduced volume. The operator must have at least an amateur license in order to operate this transceiver.

Courtesies

The authors wish to extend their appreciation to Mr. Harrison (Harrison Radio Co.), who assisted in the design of this installation, and to Mr. Blan (Blan, The Radio Man), both of whom contributed freely to make the installation a success. Other equipment supplied for the duration of the flight included Dictograph microphones; Trimm headphones; and Universal (Universal Microphone Co.) transformers.

Mr. Joseph H. Kraus supervised the shock-proof installation of the transceivers; Mr. George W. Stuart installed and tuned the short-wave antennas.

Our story would not be complete without mention of Mr. Henry W. Roberts, Aviation Editor of RADIO-CRAFT, without whose cooperation it would not have been possible to obtain the quick action at Floyd Bennett Airport, New York, and at other points which enabled us to design, construct and install the equipment in one week.

The writers are at the service of anyone wishing to duplicate this equipment.

List of Parts

- One Hammarlund Star variable condenser, 50 mmf., 7 plate, C1;
- One Blan suppressor-frequency coil unit, L4-L5 (made as per Fig. 2B);
- Three 1-ft. lengths No. 12 round buss bar, to make coils L1, L2 and L3 (made as per Fig. 2A);
- Two Universal microphone transformers, type 0075, Ch. T;
- One special R.F. choke (made as per Fig. 2C), R.F.C.;
- One Polymet midget mica condenser, 100 mmf., C2;
- One Polymet midget mica condenser, .001-mf., C5;
- Three Polymet midget mica condensers, .002-mf., C3, C4, C6;
- One Lynch metallized resistor, 50,000 ohms, ½-W., R1;
- One Lynch metallized resistor, 2 megohms, ½-W., R2;
- One C&H S.P.S.T. rotary snap switch, Sw.1;
- One Yaxley 9-leaf rotary snap switch, Sw.2;
- Six insulated tip-jacks, color-coded to suit;
- Six insulated plugs, color-coded to match tip jacks;
- Two 4-wire color-coded cables, for power supply;
- One Eby 4-prong cable connector, for power supply;
- Two Na-Ald 4-prong wafer sockets, for V1 and V2;
- One Crowe panel-mount vernier dial, for V1;
- One bakelite rod, 4 x ¼-in. in dia., for extending C1 control;
- One small flexible shaft coupling, for C1;
- Three small bakelite knobs, for ¼-in. shafts;
- One Blan aluminum shield box, 6 x 7 x 1 in. long.
- One Blan aluminum battery box, 4½ x 5 x 8 ins. long (an additional battery box is required as a replacement unit in replenishing the power supply);
- Two Blan aluminum sub-chassis brackets, 2½ x 6½ ins., cut to suit;
- One Blan aluminum plate for sub-chassis;
- One Trimm headphone set, featherweight type;
- One Blan pair of sponge-rubber ear muffs;
- One Dictograph type AR-50 damped single-button microphone, with push-button;
- Two Harrison Radio type 8G4 tubes, V1, V2;
- Two General Dry Battery type V-30AA 45 V. "B" batteries, for plate supply;
- One Burgess No. 5540 7½ V. "C" battery with pigtail negative lead, for "mike" current;
- One No. 6 dry cell, for "A" supply;
- Miscellaneous hardware, angle brackets, etc.

* Duplicate the List of Parts for the companion transceiver.

Behind the POLYMET Trade Mark



Many leading manufacturers, in both the radio and electrical industries, have come to recognize in POLYMET Products that quality, so essential to dependability. THEIR ENGINEERS DO NOT GUESS—THEY KNOW.

The successful service man does not guess, he knows that the use of POLYMET Products in replacement work is his guarantee of satisfaction.

Polymet Condensers

ELECTROLYTIC

Wet and Dry Types

PAPER

Pe-Tite Tubular
Hi-Volt in Cans
Uncased Sections
Oil Condensers (Transmitting and Industrial uses)

MICA

All Types—Midget sizes with lugs or leads. Large type for industrial uses.

TRANSFORMERS

WIRE WOUND RESISTORS

Write for new 1934 catalog now in preparation

POLYMET MANUFACTURING CORP.

833-R East 134th St. New York, N. Y.



RADOLEK CO., 134 Canal Station, Chicago

I am a Dealer ; Serviceman
I operate from Shop or Store ; Home
I own the following Test Equipment.....
My training and experience is

Name

Address

City

State.....

RADOLEK · CHICAGO

World-Wide Two Tube Short Wave Receiver

12,500 Mile reception record established! Tunes from 15 to 200 Meters. Gets foreign broadcasts, police calls, airplanes, amateurs, etc. **\$4.75**

DIRECT! Complete KIT (no drilling) with clear instructions to build this remarkable 2 tube receiver.....\$4.75

Dry cell or AC model.
Send \$1.00. Balance C.O.D. Satisfaction Guaranteed! NOT a toy!

NOT an attachment! A REAL, complete, all-wave receiver.
Harrison Radio Co., Dept. R2, 142 Liberty St., N. Y. C.

ATTENTION SERVICE MEN!

The Ideal Spraying Outfit for all Kinds of Commercial and Professional Work

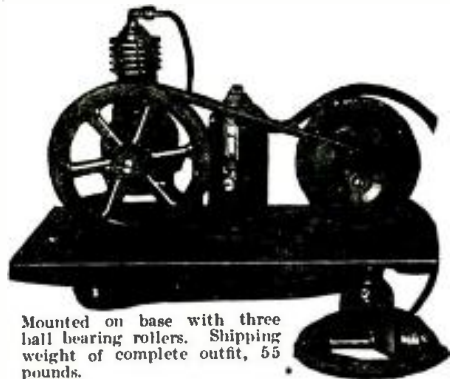

Mounted on base with three ball bearing rollers. Shipping weight of complete outfit, 55 pounds.

\$ 24⁵⁰

COMPLETE

Formerly Sold for \$68.50

This is the ideal outfit for all around spraying work wherever current is available. With this electric sprayer you can spray paint, varnish, duco, enamel, lacquer, insecticides, etc., with the speed of five men. You can move it from one room to another with ease. Simply insert plug into electric socket and this marvelous machine is ready to do a man-size job—and do it efficiently. This electric portable sprayer saves its cost over and over again on your own work. It will make money for you doing jobs for others.

This outfit comes completely equipped, nothing else to buy. It includes the following equipment: GV full-liquid pressure type adjustable gun. Non-clogging nozzle. Fan and round spray tips. 10" spread. 1/4 H.P., 110 volt, 60 cycle AC motor. Air filter tank. Kellogg Air-Cooled Compressor, size 1 1/4 x 1 3/4, Connectors and 15 ft. hose, plug, cord and five spray jars.



Price of complete outfit with gun.....\$24.50
 Price of outfit without motor.....19.50
 Price of spray gun only with five jars.....3.95
 (This spray gun alone is valued at \$20.00)

Kellogg Air-Cooled Compressors at less than half price!

Nationally known for their exceptionally high quality. We offer four different sizes at rates that represent the buying opportunity of a lifetime. All Compressors furnished with "V" pulleys.

Size	Maximum Pressure	Speed	Motor	Price
1 3/4 x 1 3/4	75 lbs.	600	1/4 H.P.	\$ 6.50
1 x 2 3/8	100 lbs.	600	1/4 H.P.	8.50
2 x 2	125 lbs.	600	1/3 H.P.	10.50
2 1/4 x 2	175 lbs.	500	1/3 H.P.	12.50



HEAVY DUTY DRILLS

Heavy Duty 3/8" Drill—110 Volt Universal Motor
 An unusual Bargain! Regular price \$22.50

Our price \$12.95

We Have No Catalog—Order From This Page

Be sure to state shipping point if express or freight is not in your town. Enclose bank draft, cashier's check, post office money order or personal certified check. No. C.O.D.'s.

WELLWORTH TRADING CO.
 111 West Lake Street, Chicago, Ill.

RC-2

I enclose \$..... for which please send me the following by Express collect:

Name
 Address City State

• Index to Advertisers •

A	
Aerovox Corporation	494
Alden Mfg. Company	493, 503
Allied Radio Corporation	496
American Sales Company	501
Arrow Sales Company	494
Autonator Laboratories, Inc.	494
B	
Birnback Radio Company	500
Blair the Radio Man, Inc.	503
Bud Speaker Company	493
C	
Central Radio Laboratories	490
Clarostat Mfg. Company	502
Classified Section	498
Coast-to-Coast Radio Corp.	490, 501
Coyne Electrical School	449
E	
Electrad, Inc.	497
F	
Fordson Radio Mfg. Company	498
G	
General Transformer Company	503
Grenpark Company	511
H	
Hammarlund Mfg. Company	494
Harrison Radio Company	507
Howard Radio Company	Inside back cover
Hygrade-Sylvania Corp.	495
L	
Leed's Radio Company	503
Leotone Radio Company	501
Lincoln Radio Corporation	491
Lynch Mfg. Company	492
M	
Midwest Radio Corporation	Back cover
Miles Reproducer Co.	503
N	
National Carbon Company	489
National Radio Institute	451
National Union Radio Corp.	501
P	
Pal Ko, Inc.	498
Polymet Mfg. Corp.	507
Popular Book Corporation	502
Postal Radio Corporation	504
Precision Resistor Company	490
R	
Radio-Amp Publishing Co.	502
Radio Circular Company	510
Radio City Products Company	496
Radio Trading Company	512
Radio Training Association	498
Radolek Company	507
RCA Institutes, Inc.	504
RCA Radiotron Co., Inc.	485
RCA-Victor Company, Inc.	503
Readrite Meter Works	499
Remington Rand, Inc.	494
S	
S. O. S. Corporation	498
Schwartz & Son, Maurice	500
Sexology Magazine	498
Shallcross Mfg. Company	494
Shure Brothers Company	488
Smith & Co., Johnson	510
Sprayberry, F. L.	502
Stewart-Warner Corp.	504
Supreme Instruments Corp.	487
T	
Triplett Electrical Instrument Co.	503
Try Mo Radio Co., Inc.	504
U	
Universal Microphone Co.	494
V	
Van Nostrand Co., D.	486
W	
Waechter Distributor, H.	494
Webster Company, The	497
Wellworth Trading Company	502, 508
Westinghouse Elec. & Mfg. Co.	493
Wholesale Radio Service Co., Inc.	492

(While every precaution is taken to insure accuracy, we cannot guarantee against the possibility of an occasional change or omission in the preparation of this index.)

The Radio-Craft Library Series covers accurately every branch of Radio—and thoroughly, too

Presented on this page are the new books of the RADIO-CRAFT LIBRARY—the most complete and authentic set of volumes treating individually, important divisions of radio. Each book has been designed to give radio men the opportunity to specialize in one or more of the popular branches of the industry. The material contained

in these books will increase your knowledge; you will find them a real help in your work and they will contribute to your money earning capacity. Read these books during your spare time at home. The authors of these books are well-known to everybody. Each one is an expert radio man; an authority on the subject—each is thoroughly

familiar with the field which he represents. This is perhaps the first real opportunity that you have ever had to build a radio library of books that are authentic, right-up-to-the-minute and written so that they are easily digested and clearly understood. Mail coupon below for your books.

TO THE RIGHT WILL BE FOUND A SHORT RESUME OF EACH BOOK

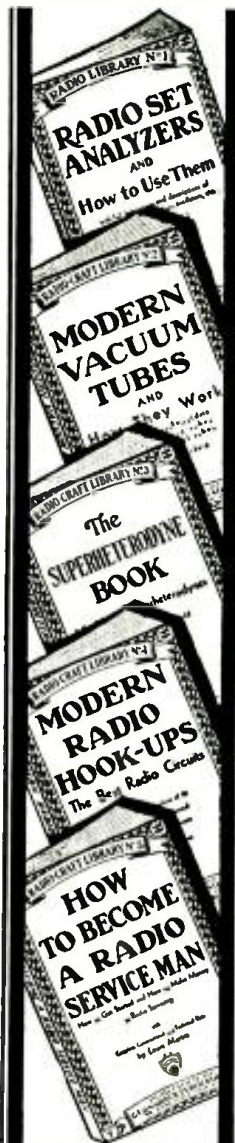

Book No. 1
Radio Set Analyzers
And How To Use Them
With Full Instructions and Descriptions of Set Analyzers, Tube Checkers, Oscillators, Etc.
By L. VAN DER MEL
This book explains thoroughly the operation of set analyzers, tube checkers, oscillators and other testing equipment. For every radio man this book is extremely helpful. It covers every phase of testing and gives you valuable short cuts; completely illustrated with photographs and diagrams to facilitate the use of modern testers. Recently reprinted.

Book No. 2
Modern Vacuum Tubes
And How They Work
With complete Technical Data on All Standard and Many Special Tubes
By ROBERT HERTZBERG
MODERN VACUUM TUBES describes the fundamental electron theory which is the basis of all vacuum tube operation, and goes progressively from the simplest two-element tubes right up to the latest pentodes and thyatrons. It is written in clear, simple language and is devoid of the mathematics which is usually so confusing. Valuable reference charts and characteristic curves of standard and special tubes are to be found, also diagrams of sockets and pin connections.

Book No. 3
The Superheterodyne Book
All About Superheterodynes
How They Work, How to Build and How to Service Them
By CLYDE FITCH
There is no more fascinating a subject in the large array of radio circuits than the famous superheterodyne circuit. Whether you are a Service Man or experimenter, first-hand knowledge about the construction of superheterodyne receivers is very important. The book on Superheterodynes gives underlying principles of their construction, right from the very first set made.

Book No. 4
Modern Radio Hook-Ups
The Best Radio Circuits
A Complete Compendium of the Most Important Experimental and Custombuilt Receivers
By R. D. WASHBURNE
It is fascinating to the experimenter, or even to the up-to-date Service Man, to take a commercial set and to change it into one using a famous hookup that is not found in any manufactured set. Many excellent circuits have never been commercialized, but limited only to home set builders. Thousands of these popular circuits have been requested from time to time, and in this book we have included over 150 circuits, which include the famous Perlydne, Cash-Box A.C.-D.C. Set and others.

Book No. 5
How to Become a Radio Service Man
How to Get Started and How to Make Money in Radio Servicing
By LOUIS MARTIN
The ambition of many men in radio today is to become a first-grade Service Man. It is not as difficult as one might believe, but it cannot be done in a few short months. Following very carefully the advice of Mr. Martin, who has dealt with the problems of thousands of Service Men, this book deals very carefully with the essential stakes in the preparation for qualifying as a Service Man.

Book No. 6
Bringing Electric Sets Up to Date
With Pentodes, Multi-Mus, Dynamic Speakers—Complete Information How to Modernize A. C. D. C. and Battery Operated Receivers
By CLIFFORD E. DENTON
In this country there are over ten million electrically operated receivers that could be modernized—by plugging in them new type tubes, new speaker equipment and other modern improvements. This business of improving old sets can go to the experimenters and Service Men if they will quickly jump into action.

Book No. 7
Radio Kinks and Wrinkles
For Service Men and Experimenters
A Complete Compendium on the Latest Radio Short-Cuts and Money-Savers
By C. W. PALMER
It often becomes necessary for experimenters and Service Men to call upon their memory for some short cut or radio wrinkle that will solve a problem quickly. In business, "short cuts" mean time and money saved, and to the Service Man "time saved" means money earned.

Book No. 8
Radio Questions and Answers
A Selection of the Most Important of 5,000 Questions Submitted by Radio Men During the Course of One Year
By R. D. WASHBURNE
There have been collected a wide variety of questions which have come into our editorial offices during the past two years, and only those whose answers would benefit the majority of men engaged in radio have been incorporated in this amazing question and answer book. A tremendously long list of topics is treated.

Book No. 9
Automobile Radio and Servicing
A Complete Treatise on the Subject Covering All Phases from Installing to Servicing and Maintenance
By LOUIS MARTIN
Automobile radios are up and coming, and someone has to service them properly. It therefore behooves you to read this immensely important new book on the art of Automobile Radio. The book is concise, and full of illustrations, photographs, diagrams and hookups. A few of the really interesting chapters: Introduction; Automotive Radio Installations; Complete Descriptions of Commercial Automotive Receivers; Servicing Automotive Receivers; The Ignition System; General Service Considerations; Effects of Temperature on Power Supply; Conclusion.

Book No. 10
Home Recording and All About It
A Complete Treatise on Instantaneous Recordings, Microphones, Recorders, Amplifiers, Commercial Machines, Servicing, etc.
By GEORGE J. SALIBA
If there is one subject that is fascinating to every radio man, it is that of Home Recording. Of course, this volume is not all on "Home" recording, but the information contained therein is important to commercial radio men, studio operators, engineers and others interested in this phase of radio.

The art of recording and reproducing broadcast selections is becoming more important every day to radio men, experimenters and Service Men. Equipping dance halls, auditoriums, churches, restaurants and homes with public address systems and amplifiers brings many extra dollars and often an excellent income.

Book No. 11
Point-to-Point Resistance Measurements
The Modern Method of Servicing Radio Receivers
By CLIFFORD E. DENTON
Of the difficult problems which Service Men face today when repairing receivers, the greatest is that of replacing proper resistance values in sets. This task becomes even more difficult when the values of resistors are unknown; and manufacturers of many standard sets do not pass this information on to Service Men. In this new book radio men will find the information needed to quickly place a receiver in normal operating condition. This book cuts in half the time usually required to adjust the average set. Sufficient space has been devoted to the elementary problems and the theory of electricity as it is applied to resistance measurements so that the Service Man will have a comprehensive idea as to how to overcome this problem.

Below you will find a partial list of the contents which will appear in this new book:
INTRODUCTION. Advantages of Resistance Measurement Method of Servicing for Radio Work; Basic Principles; Methods of Resistance Measurement; Resistors in Radio Receivers and Amplifiers; Point-to-Point Resistance Measurements in Typical Radio Sets using Ohmmeter; Resistance Measurements using Modern Tester; Routine Testing where Circuit Diagram is Available and where Resistances are Known; Routine Testing where Circuit Diagram is Not Available and where Resistances are Unknown; The Relation of Voltage Testing Methods to Resistance Measurement; APPENDIX. Resistance Charts etc.

ALL BOOKS UNIFORM

The books in the new RADIO-CRAFT LIBRARY are all strictly up-to-date, and written by men who know their subjects. The volumes are all uniform size, 6x9 inches, and contain on an average of 50 to 120 illustrations. Each book is printed on fine book paper and no expense has been spared to make it an outstanding value, for its editorial contents as well as from the mechanical standpoint.

Clip Coupon and Mail Today!



GERNSBACK PUBLICATIONS, INC., 96-98 Park Place, New York, N. Y.

I have circled below the numbers of books in the RADIO-CRAFT LIBRARY, which you are to send me, and have deducted 20% for ordering five (5) books or more. I have included my remittance in full, at the price of 50c each, when less than five books are ordered.

The amount of my remittance is.....(Stamps, checks or money orders accepted.)
Circle numbers wanted: 1 2 3 4 5 6 7 8 9 10 11

Name Address

City State RC-284

Big Discount to You

In order to make it possible for everyone to buy these books, the fifty (50) cent price has been made uniform for all volumes. You can buy these books separately, but you should take advantage of our special offer:

When Five (5) Books or More Are Ordered

Deduct 20% from Your Remittance

Simply fill in the coupon at left, and mail it to us together with your remittance. Checks, stamps or money orders accepted.

JAPANESE ROSE BUSHES

The Wonder of the World

Japanese Rose Bushes bloom all the year round. Just think of it. Six weeks after planting the seed, the plants will be in full bloom. It may not seem possible, but we positively guarantee it to be so. They will bloom every two weeks, Summer or Winter, and when three years old the bush will be a mass of roses, bearing from five hundred to a thousand roses on each bush. The flowers are in three shades—white, pink, and crimson. The plants will do well both in and out doors. We guarantee at least three bushes to grow from each packet of seed. Price, 10c packet, 3 pkts. for 25c postpaid.

Chinese Fragrant Tree Fern

Just introduced, noted for its rapid growth. An exceptionally pretty ornamental plant. Foliage is rich dark green. Forms grand pyramidal bushes about 2 feet high, branching out desirable for decorative purposes, wreaths, etc. Seeds 15c packet, 3 for 40c.

Weather Plant

NATURE'S WEATHER PROPHECY
By mysterious means that take place, this remarkable plant accurately forecasts the weather many hours in advance. Will grow anywhere all the year around. An interesting house plant. Large, fragrant, pink, butterfly shape flowers. Seeds, 15c packet, 3 for 40c, postpaid.

GROUND ALMONDS

Amazingly Prolific—Easily Grown From Seed
The Ground Almond has a flavor that is MOST EXCELLENT, resembling the coconut. The most is shown white, covered with a shell of brown color. It grows close to the surface and anything from 200 to 300 Almonds may be expected from a single unit. There is no trouble whatever in growing any kind of fruit. May be planted any time, and in eight or ten weeks from time of sowing you will have an ENORMOUS CROP of the MOST DELICIOUS ALMONDS YOU EVER TASTED. Price, 15c Pkt.

Chinese Cabbage

Novelty from China and should be grown in every garden. Seems to be a cross between Celery and Cabbage. Flavor is more mild than any other cabbage. Can be served on the table and eaten raw or cooked like cabbage, spinach or lettuce or made into salad. Grows very rapidly, easy to cultivate. You can create great sensation by cultivating this remarkable novelty. Seeds, 15c packet, 3 pkts. for 40c.

TREE OF HEAVEN

This splendid ornamental tree is a native of China, and is called the Tree of Heaven, on account of its great height. It is very hardy, thrives in any soil, no matter how poor, and grows from 6 to 10 feet high from seed the first summer. The leaves are from 5 to 6 feet in length, giving it a grand appearance. Nothing outside the tropics can rival it for lawn decoration. In late June or July, they give forth in season by great clusters of colored seed pods, make the tree a continual thing of beauty. Packet, 15c; 3 packets 40c.

THE REMARKABLE FIREFLY PLANT

Blooms at Night
Fills the Atmosphere with Fragrant Aroma
One of the most rapid growing vines known. Under favorable conditions this vine has been known to grow OVER 20 FEET IN A SINGLE WEEK. In a very short space of time indeed the plant has climbed to a great height, and is covered with IMMENSE FLOWERS. It is, indeed, a great novelty for, unlike other plants, the flowers OPEN IN THE EVENING, and remain open until about noon the following day. In dull weather they will remain open all day. It is a MOST INTERESTING SIGHT to watch the opening and closing of the flowers as the clouds around it full of scented fragrance. It is always the object of favorable comment, and much curiosity is aroused by people passing at night time as to the cause of the charming aroma frequently encountered at night. Price, 15c packet, two packets for 35c. POSTPAID. JOHN SMITH & CO.

The Great Wonderberry

A luscious berry that may be grown and ripened in 100 days. It is a seed in any soil or climate in any form. The flavor is fine and unparelleled. It is a most interesting sight to see the fruit, rich blueberry. One bush will produce an enormous amount of fruit, yielding great masses of rich fruit all Summer and Fall. Packet, 10c, 3 pkts. for 25c, postpaid.

Shoo Fly Plant

A very remarkable botanical curiosity you should have. Though quite odorless, it is said that it will remain a root where it is sown. Bears very pretty blossoms all Summer and winter. Grows rapidly from seed. SEEDS 15c PKT; 3 for 40c, postpaid.

The Great Umbrella Palm

A graceful House or Conservatory Plant
Easily Grown From Seed Winter or Summer
The Japanese Umbrella Palm is a semi-aquatic plant. It is easily grown in a bowl of water or in very damp soil. Probably the most usual, as well as the most interesting method, is to cultivate the plant in a bowl of water. The plant grows to three or four inches of good garden soil at the bottom. The seeds soon commence to germinate, and the plant shoots up stems and leaves like a young palm. The top of the stems are surrounded by a whorl of umbrella-shaped leaves, of a very appearance. We will send a package of this seed, with full instructions for culture, for only 15c or three packets for 40c postpaid.

Banana Musk Melon

Quite a curiosity. Looks and tastes like a banana. Popular shape and its delicious flavor make it well worth your while cultivating. It is deep and of exquisite flavor. Very high priced when obtained in other city markets, as high as a dollar sometimes being demanded for one single specimen. Seeds 10c, 3 pkts. for 25c.

Perfume Plant

Blooms only at night, giving forth the most delightful scented fragrance for quite a distance. Castoreum made from it. SEEDS 10c PKT; 3 for 25c.

CACTUS FROM SEED

Very curious, odd looking, strange specimen of plants, will thrive anywhere with little or no care. Flowers are of exquisite beauty and delightful fragrance. The seeds will be astonished at the old looks of the cactus just sprouting from three packets for 25 cents, postpaid.

GIGANTIC NEW GUINEA BUTTER BEANS

THE NEW GUINEA VEGETABLE WONDER
Grows to an astonishing size, the Beans measuring from 3 to 6 feet long, and weighing anything from 10 to 16 lbs. One plant is sufficient for a family for several weeks. Very palatable and rich in nutritious materials. The delicate Buttery Flavor is much appreciated. The seeds are easily grown, very prolific, and a most welcome and valuable adjunct to your garden. Try them; you will find them the most delicious vegetable you have ever tasted. Imported direct. Unobtainable elsewhere. Sample package of seeds with full directions for cultivating and cooking. 25c, postpaid.

Kudzu Vine

Most rapid growing vine known. Will grow 20 feet in one week. Luxuriant foliage, lovely purple flowers, very fragrant. Nothing so equal to it for shade purposes and quick growth. Seeds 15c packet, 3 for 40c.

Yard Long Bean

Produces enormous crop of long, slender, crisp pods of excellent quality for snap beans. Pods grow from 2 to 5 feet in length. Very tender and fine flavor. The vines are rampant growers; an interesting and profitable crop. Seeds 15c pkt., 3 for 40c.

Blank Cartridge Pistol

REVOLVER STYLE

25c
50c
\$1.00

MADE IN 3 SIZES



Three new models now out 25c, 50c and \$1.00. Well made and effective. Modelled on pattern of latest type of Revolver. Appearance alone enough to scare a burglar. Takes 22 Cal. Blank Cartridges obtainable everywhere. Great protection against burglars, tramps, dogs. Have it lying around without the danger attached to other work starting pistol, etc. SMALL SIZE 4 in. long 25c. MEDIUM SIZE 5 in. long 50c. LARGE SIZE 6 in. long \$1.00. BLANK CARTRIDGES 50c per 100. HOLSTER (Cowboy type) 50c. Shipped by Express only, not prepaid. 710 page catalog of other pistols, sporting goods, etc. 10c

BOYS! THROW YOUR VOICE

THE VENTRILO

a little instrument, fits in the mouth out of sight, used with above for Bird Calls, etc. Anyone can use it. Never fails. A 16-page course on Ventriloquism together with the Ventrilo. All for 10c postpaid.



PLAY PIANO IN ONE HOUR

With this new VAMPING BOARD. No teacher needed. Surprisingly simple. Place the Vamping Board upright over the piano keys, and vamping away thousands of songs, ballads, waltzes, fox trots, rag time, etc. No knowledge of music required. After using it a few times, the Board may be dispensed with entirely. Price 15c postpaid.



Novelty French Photo Ring

Here is a very great novelty in Rings, that is selling in thousands. It is a nicely made ring, finished in imitation platinum, and set with a large imitation diamond. It looks just like an ordinary ring, but in the shank of the ring is a small microscope picture almost invisible to the naked eye, yet is magnified to an almost incredible degree and with astonishing clearness. There is quite an assortment of pictures that should suit all tastes. Some are pictures of bathing girl beauties, pretty French Actresses, etc., others are views of places of interest in France, Panama Canal and elsewhere; others show the Lord's Prayer in type every word of which can be read by persons with normal eyesight. They are interesting without being in any way objectionable. PRICE 25c, 3 for 65c, or \$2.25 per doz. postpaid. 720 page Catalog 10c.



TELL YOUR OWN FORTUNE Learn to Hypnotize

DREAM BOOK
With the aid of this dream book and fortune-teller. Will you be lucky in love? Successful in business? Will you be wealthy? Complete with dictionary of dreams with descriptions and explanations of dream symbols, fortune-telling, oracles, divination, and more. Price 10c postpaid.

HYPNOTIC
This book tells how. Explains all about Hypnotism, how to hypnotize, how to produce sleep, how to awaken a subject, medical hypnotism, hypnotism in disease, how to hypnotize animals, illustrations, etc. 27 chapters. ONLY 10c ppd.



PISTOL CIGARETTE CASE

It looks like a deadly weapon, but it is merely a novel Cigarette Case. This clever contrivance has proved itself better than the real thing in many an awkward encounter. Great fun "sticking up" your friends. They squirm and protest it might be loaded. Pull the trigger and the slide flies open disclosing the cigarettes. Well made, light and compact. Weight only 2 ounces. PRICE POSTPAID 25c



SEX INDICATOR

An amusing and entertaining novelty. Hold it over a woman's face and it is supposed to describe a complete and continuous circle. Hold it over a man's face and it will move back and forth like a pendulum. We have made innumerable tests, and while we have never been able to figure out how it's done, we have never seen it fail. It is a novel and interesting experiment. Price 10c postpaid.



ADDRESS ORDERS FOR GOODS ON THIS PAGE TO

JOHNSON SMITH & CO.

DEPT. 946 RACINE, WIS.

Our complete Catalog sent on receipt of 10c., or the De Luxe Cloth Bound Edition for 25c. Bigger and better than ever. Only book of its kind in existence. Nearly 800 pages of all the latest tricks in magic, the newest novelties, puzzles, games, sporting goods, rubber stamps, unusual and interesting books, curiosities in seeds, odd plants, etc., unobtainable elsewhere. Remit by Coin, Money Order, Check or unused U. S., Canadian and Foreign Stamps for all articles listed above.

LATEST CATALOG



MAKE YOUR OWN RADIO RECEIVING SET

Enjoy the concerts, baseball games, market reports, latest news, etc. This copy-righted book "EFFICIENT RADIO SETS" shows how to make and operate the expensive Radio Sets, the materials for which can be purchased for a mere trifle. Also tells how to build a short-wave Receiver for listening in a foreign station, police calls, ships at sea, etc. ONLY 15c. postpaid.



SILENT DEFENDER

Used by police officers, detectives, sheriffs, night watchmen and others as a means of self-protection. Very effective. Easily fits the hand, the fingers being grasped in the four holes. Very useful in an emergency. Made of aluminum they are very light, weighing less than 2 ounces. Handy pocket size always ready for instant use. PRICE 25c each, 2 for 45c postpaid.



BIG ENTERTAINER

180 Jokes and Riddles, 34 Magic Tricks, 64 Parlor Games, 73 Toasts, 15 Tricks with Cards, 50 Money-making Secrets, 10 Funny Readings, 3 Monologues, 21 Puzzles and Problems, 5 Comic Recitations, Cut-outs for Checkers and Chess, Dominoes, Fox and Goose, 9 Men Morris, Spanish Prison Puzzle, Game of Anagrams, etc. All for 15c postpaid.



WONDERFUL X-RAY TUBE

A wonderful little instrument producing optical illusions both surprising and startling. With it you can see what is hidden in the hollow of your fingers, the lead in a lead pencil, the interior opening in a pipe stem, and many other similar illusions. Price 10c, 3 for 25c.



ITCHING Powder

This is another great practical joke! The itching powder causes more than 100 victims to everyone, but themselves in thorough enjoyment. It is necessary to start the ball rolling is to deposit a little of the powder on the back of the hand and the powder can be rolled upon to do the mischief. Between the fingers of your fingers, the lead in a lead pencil, the interior opening in a pipe stem, and many other similar illusions. Price 10c, 3 for 25c.



ANARCHIST BOMBS

One of these glass vials dropped in a room full of people will cause more consternation than a lumbering chess. The smallest will disappear in a short time. 10c per box, 3 boxes for 25c, 75 per doz. gross boxes \$7.50 per gross boxes. Shipped by Express. Not Prepaid.



SNEEZING POWDER

Place a very small amount of this powder on the back of your hand and blow it into the air, and watch the sneezing commence. You know the reason why. It is most amusing to hear the remarks as they never suspect the real source, but think they have caught it one from another. Between the fingers and sneezing you yourself will have the time of your life. For parties, political meetings, car rides, or any place at all where there is a gathering of people, it is the greatest joke out. PRICE 10c, 3 for 25c, 75c per dozen. Shipped by Express. Not Prepaid.



COMICAL MOTTO RINGS

Lots of harmless fun and amusement wearing these rings. Made in platinum finish (to resemble platinum), with wording on enamel, as illustrated. Price 25c. ac. Postpaid.



Good Luck RING

Very striking, quaint and uncommon. Oxidized platinum finish; skull and crossbones design; and two lines in a thin imitation rubies or emeralds sparkle out of the eyes. Said to bring good luck to the wearer. PRICE 25c Postpaid



FORTUNE TELLING BY CARDS

Dice, dominoes, crystal, etc. Tells meaning of every card. Different methods explained. Complete full with complete information. PRICE 10c postpaid.

HERE IS A GROUP OF FINE QUALITY RADIO PARTS THAT "Shouts" ..

VALUE!

Mershon Triple 10 Mfd. Electrolytic Condenser



A genuine Mershon Electrolytic condenser at this low price for the first time. Contains three 10 mfd. condensers in one. Used as a replacement in many different receivers. Proven design, puncture-proof, constant capacity—are the features which distinguish this condenser from others. Positive terminal leads are brought out to bolts on top of the condenser. Negative is grounded to the container.

Price **\$1.25**

POWERTONE SENDING KEY

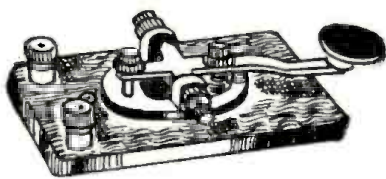

This popular design is widely used as a low power transmitting and code practice key. Mounted on a mahogany finished base. The key is well-balanced and fully adjustable for clearance and tension. Contacts are designed for heavy service. A commercial key at the amateur's price. Base dimensions 5 1/4 inches long and 2 3/8 inches wide.

Price **79c**

CROSLY POWER TRANSFORMERS

Constructed of the finest materials. Large oversized construction insures freedom from heating. Massive core and oversized coil provides long trouble free life.

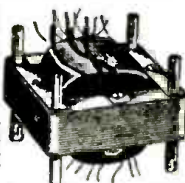

I. H. model supplies the following voltages:
1 1/2 volts for 4-226; 2 1/2 volts at 2 amps. for 1-227; 5 volts at 1/2 amp. for 1-171A; Winding for Raytheon Type B.H. tube; 250-250 High voltage; Primary 110 volts A.C. 60 cycle. Price **\$1.00**

Fast .06-.06 Condenser



A high grade by-pass condenser made by one of the foremost condenser manufacturers in the country. Contains two .06 condensers in one can. Separate terminals are brought out for the common connection and both positive. Can is not grounded.

Price **12c**



60,000 ohm Ward Leonard Vitrohn Resistor

A high grade well known heavy duty resistor. Will dissipate 25 watts continuously. Total resistance is 60,000 ohms tapped at 1500. Comes completely mounted on a bakelite strip to ease installation. Bakelite strip measures 4 inches in length and 1 1/4 inch wide.

Price **19c**

4 Prong Bakelite Socket



We bought a great quantity of these sockets before the price rise. Here is your chance to stock up. They will go fast at this low price—send in your order now. Phosphor-bronze contacts assure permanent connection.

Price **5c**

CROSLY DOUBLE CHOKE

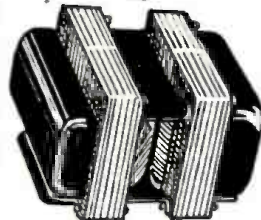

A unit consisting of two chokes which can easily be separated. Each choke is rated at 30 henries at 60 mhos. Sturdily constructed and will handle an overload of 15%. Fully shielded in an attractive black enameled can. Measurements: 3 3/4 ins. long, 2 1/4 ins. high and 2 3/8 inches wide. Each choke contains separate terminals.

Price **69c**

R.C.A. VICTOR HAND MIKE

Provides true toned reproduction of music and voice. Ideal for use in home recording systems, and as a home broadcasting mike. Widely used in a neat portable public address systems. Neatly finished in brown gun metal enamel—complete with 5 foot cord.

Our Price **\$1.25**

FARRAND INDUCTOR DYNAMIC SPEAKERS--9" MODEL

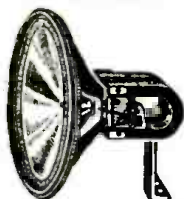

The ideal short wave receiver speaker; eliminates hum and line noise; draws less current; absolutely genuine Farrand; compact in size; brings in the very weak short wave stations.

Do not confuse this model with the various similar types on the market posing as Farrands.

This is the true Farrand Inductor Dynamic. Its adaptation to Short Wave Radio Receivers has proven a popular step. The most intricate stations are brought in with remarkable clearness without the customary noise and hum of regular dynamic speakers. Has two magnets parallel to each other with a bracket placed between them to facilitate mounting. Overall 9" model. Please state power tube when ordering.

Price **\$3.95**

12" MODEL

The Genuine Farrand Inductor For The First Time At This Low Price

These models are not to be confused with the various types now on the market and labeled Farrand Inductors. These models are all factory built and not just put together haphazardly.

The 12 inch models have two magnets standing upright, with a bracket on the bottom to ease mounting. Dimensions of the 12 inch model: 12 inches high and 6 1/2 inches deep. (12" Model)

Our Price **\$4.95**

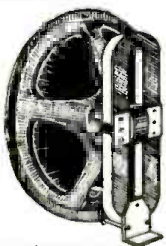

GENUINE R. C. A. MAGNETIC CHASSIS

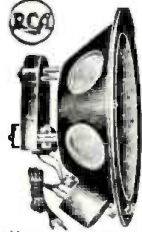

This chassis is the identical one used in the R.C.A. 100A-100B Speakers which list for as high as \$35.00. Note built-in output transformer which permits use of 150 volts without distortion, rattling or blasting. Generous oversized magnet. The thick armature is accurately centered, the sturdy metal frame is lined with a special self-buffing fabric, greatly improving acoustic properties of this sensational speaker. Note the corrugated surface of the cone, an exclusive feature—enhances perfect reproduction qualities considerably; most compactly made; 9" outside diameter, 4 1/2" deep overall.

Price **\$2.50**

Replacement Unit

The genuine replacement unit mechanism for the R.C.A. 100A, 100B, and 103 speaker chassis. This unit is complete in every detail except that it is furnished less the magnet. Guaranteed to be in perfect condition. Can also be used for replacement purposes on any other type speaker.

Our Price **95c**
With Magnet **\$1.25**

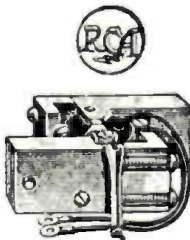

BALDOR Television Motor

A silent synchronous motor used in the Jenkins Television Receivers. All genuine brand new Baldor Motors.

SPECIFICATIONS

Type M 2 C R
H. P.—1/15
R. P. M.—1700
Volts—110 volts
A.C.—60 cycle
Amp.—1.0
Ph.—1



Standard shaft 3/8 inches long. Overall height 8 inches. Width 4 1/2 inches.

Price **\$6.95**

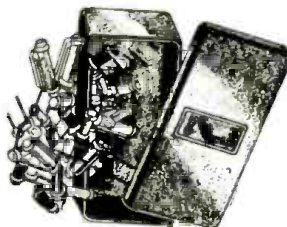

Handy Kit of 50 R.M.A. Color Coded Resistors 1/2-1 1/2-1-Watt

A complete assortment of resistors which will prove invaluable to the service bench. Their long lined leads and small size permit easy insertion or replacement. A contact kit and easy to carry. Old values can be obtained by connecting two or more values in series or parallel. R.M.A. color coded for easy identification.

FREE—With each assortment of 50 resistors a beautiful bakelite case—assortment of the Chicago Century of Progress Exposition. Size of box: 6 1/4 x 3 1/4 x 1 3/4 inches.

Price **\$2.95**

All orders are F. O. B. New York, and subject to prior sale. Terms: A deposit of 20% is required with every order. Balance may be paid on delivery. Deduct 2% if full amount is sent with order. **DO NOT SEND FOR CATALOG**

GREN PARK COMPANY

245 Greenwich St.

Dept. RC

New York, N.Y.

RTC's Big February SPECIALS

Every month we list on this page a few STAR* items which are not listed in our catalog. These are all specials on which the quantities on hand are not sufficient to catalog them. *Once sold out, no more can be had. ORDER NOW—TODAY.*



**No One in Radio
Undersells Us!**

STOP SHOPPING—the lowest prices are right on this page. *No one undersells us.* We meet any price on any new merchandise. Order direct from this page and save money. 100% satisfaction on every transaction. Take advantage today of these special offers.

★ Colonial Remote Control Attachment COMPLETE . . . NOTHING ELSE TO BUY

Imagine the convenience of just sitting back in an easy chair or lying in bed and merely by pressing a series of buttons, starting the radio located in a far off room or hidden away in the basement. Not only that, but selecting one of ten stations from a remote point. If this is the machine age, it is also the age of convenience. The remote control is a machine designed to tune your radio automatically. Why not take advantage of it, especially when it is priced more than 300% below its original list value.

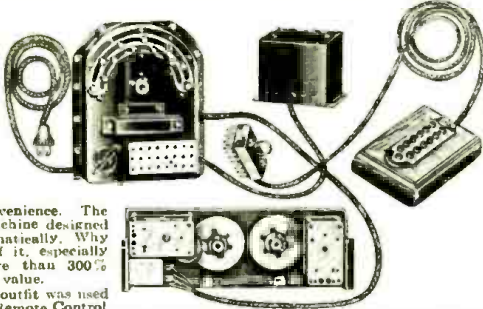

This remote control outfit was used on one of the Colonial Remote Control receivers which sold for more than \$300.00; yet you or anyone at all handy with tools can attach it to your own radio. You can then hide the radio either in the closet, basement, or some other out-of-the-way place and extend wires to a number of speakers strategically located in various parts of your apartment. Imagine the surprise of your friends or guests at dinner or at special gatherings, when, by merely pressing a button the room is gradually flooded with beautiful music or other entertaining programs, by the hidden speakers. Aside from being a novel idea it is also a very practical one.

RADIO SERVICE MAN AND CUSTOM SET BUILDER—HERE IS YOUR OPPORTUNITY

You need not mention the words "remote control" to your customer and immediately you command his entire interest and attention. You are able to do this because the idea to him, is new and because it immediately implies expensive equipment. However, when you inform him that you can construct or ADAPT HIS RECEIVER FOR REMOTE CONTROL OPERATION for only a few dollars more, his interest will almost certainly materialize into an order. We need not give YOU any more talking points on this subject because you probably can muster up more than we.

EXTREMELY SIMPLE TO OPERATE

The outfit comprises two small motors (one for turning the tuning condenser and the other for turning the volume control), a 10-position commutator switch for selecting 10 different stations, a step-down transformer for exercising the motors and a 13 button control board (10 buttons for the 10 stations, two buttons for increasing or decreasing the volume and one button for silent tuning). A pilot light in the control board indicates when the receiver is operating.

If the shafts of the tuning condenser and volume control of your present receiver can be extended so that the commutator switch and one of the motor gears can be slipped over the tuning condenser shaft and the other motor gear on the volume control shaft then you can easily adapt this outfit to your receiver DIRECTLY, without any further changes. With some sets it may be necessary to remove the volume control entirely from the chassis and mount it at the rear of the volume control motor. Custom set builders need have no hesitations about this remote control, inasmuch as they can design the physical layout of their sets to conform with this equipment. The illustration clearly shows all component parts of this complete remote control system. Shipping weight 1 lb.

No. 1789 Colonial Complete Remote Control Outfit
YOUR PRICE, Only \$5.90

BUILD THE "NEW DEPENDABLE" TUBE TESTER

Sold Either Wired or in Kit Form

Here indeed is your opportunity to build one of the finest tube checkers ever designed—an instrument which is MODERN in every sense of the word. Will test all the latest type tubes, including those with 7 AND 8 PRONGS—DIRECTLY—without the use of a single adapter!

The "NEW DEPENDABLE," despite its high degree of accuracy, is extremely simple to operate. Both plates of the 80-82-83 and other rectifier tubes are readily tested without the use of a "second plate" button.

The instrument employs a high-grade, D'ARSONVAL TYPE, MOVING-COIL, METER, insuring thereby, extreme accuracy. This instrument will check more than 120 different tubes and even those which have not as yet been placed on the market. The tube tester is amply guarded against tube "shorts," which condition is indicated by the flashing of a small pilot light. All component parts are mounted on a beautifully etched panel and the entire instrument placed in a sturdily constructed, leatherette-covered, carrying case. For operation on 105-125 volts, 50/60 cycles, A.C. This instrument is available either in kit form or completely wired and tested, ready to use. Shipping weight 9 lbs.

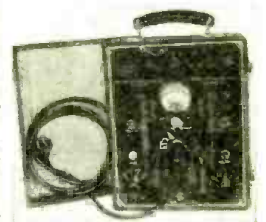

NO. 303 "New Dependable" Tube Tester, completely wired and tested.
YOUR PRICE..... \$18.76

NO. 303 A "New Dependable" Tube Tester in kit form.
YOUR PRICE..... \$14.76

NEW Service Men's Wire Wound Fixed Resistor Kit Only 100 Kits Left

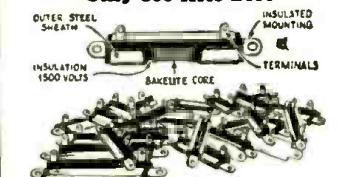

You have probably never seen a resistor of this type before. It is new, it is radically different from other resistors, both in construction, accuracy and maintenance of calibration. These resistors are wound in the strictest sense of the word. A heavy steel covering around the fine wire resistance element protects it indefinitely and prolongs its life. A resistor of this type may be used over and over again from set to set, without losing its accuracy or wearing out. The kit consists of 84 resistors, only four of which are duplicated. In other words there are more than 80 different values. If these units were bought individually, they would cost more than \$16.50. The kit contains one each of the following values: 20 ohms C.T., 40 C.T., 60 C.T., 50 ohms, 100, 150, 250, 300, 400, 600, 1250, 1500, 2000, 2500, 3000, and two each of the following: 300 ohms, 500, 750 and 1000.
No. "Mu-Kit" Service Men's Wire Wound Fixed Resistor. **YOUR PRICE \$2.77**

A Real Microphone at the Price of a Toy

Here is the largest value ever offered in a commercial type microphone! An unusually large two-button microphone, ruggedly constructed and designed especially for broadcast purposes. Frequency range 30 to over 6,000 cycles—adequate for all speech and music reproduction. EXCELLENT FOR PUBLIC ADDRESS WORK. Stretched cushioned diaphragm of duralium with pure gold center contacts on buttons and diaphragm. Standard 200 ohms per button. Finished in beautiful polished chrome. Net weight 1 1/2 lbs. Ship weight 2 lbs.
No. "F" 2 Button Mike **\$4.96**
YOUR PRICE..... \$4.96

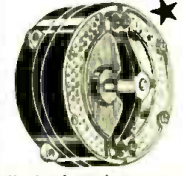

JUST OFF THE PRESS and it's FREE!



NEW 1934 Edition
108 Pages—
100 Hook-ups—
1500 Illustrations

NOT JUST ANOTHER CATALOG

Every time a new edition of our RADIO AND SHORT WAVE TREATISE comes off the press it is an event. This completely revised and enlarged 1934 edition contains 108 solid pages of useful radio information, diagrams, illustrations, radio kinks and real live radio merchandise. It contains more valuable radio information—more real live "meat"—than many textbooks on the subject. As usual considerable space has been devoted to the beginner in radio. **PARTIAL LIST OF CONTENTS:** Chapter Two of "Fundamental Principles of Radio for the Beginner"—The New Tubes. How to Make Money with Public Address Systems. How to Install and Maintain Them—How to Revamp Six-Volt Battery Sets to Use Two-Volt Tubes. How to Build the "R T" Beginner's Transmitter. How to Build the Famous Twinplex Short Wave Receiver. A Most Modern and Complete Tube Chart including Socket Connections for all Tubes, etc.

WRITE TO-DAY Enclose 4c for postage—Treatise sent by return mail.

NEW READRITE MODEL 710 ANALYZER TESTS LATEST TYPE 6 AND 7 PRONG TUBES

NINE METER SCALES AVAILABLE

This new Readrite precision instrument embodies features which have always been desired in any instrument built for service work: (1) low cost; (2) simplicity of design; (3) accuracy of measurements; (4) ruggedness of the complete unit. It is needless to add that the kit is capable of testing anything from old battery models to the latest screen-grid, pentode, and multi-mu receivers.

The "Model 710" is an extremely compact device. The outside dimensions of the carrying case are only 10 1/2 by 7 1/2 by 3 1/2 inches. The analyzer contains a D.C. voltmeter, an A.C. voltmeter and a milliammeter. The D.C. voltmeter has four ranges: 0 to 10; 0 to 50; 0 to 300 and 0 to 600 volts. The A.C. voltmeter has three ranges: 0 to 10; 0 to 140; and 0 to 700 volts. The milliammeter has two ranges: one for 15 mill reading and the other for 150 mill. This variety of ranges makes it possible to test every conceivable radio circuit; high voltage secondary of power transformer, current drain of all radio tubes, including both vacuum and 210 tubes, etc.

CONVENIENT SELECTOR SWITCH—The instrument is equipped with a ten position bipolar selector switch, by means of which readings may be obtained of "C.T." volts, "C" volts reversed, "K" volts, "K" volts reversed, plate voltage, screen-grid voltage, etc. A 4 1/2-volt battery is supplied with the analyzer, to provide "C.T." volts for grid tests, etc.

57 PENTODES, "MULTI-MUS", "57's" and "58's"—80 RECTIFIERS, Etc.—There are four sockets on the panel of the analyzer to take care of the four, five, six and seven Prong Tubes. There is a "grid-test" push-button. The jacks are available for the individual use of all meters; externally in every range. There is a green-grid pin jack and there are two pin jacks for connecting the external battery. Both plates of the 80-type rectifier may be tested by use of a special adapter furnished. Charts are provided for measuring resistances and capacitance. The Analyzer is furnished complete with test leads, connecting cables, Burgess 4 1/2-volt battery, several battery leads, UY to UX adapter, 80 rectifier adapter and resistance and capacity charts. Shipping weight 1 1/2 lbs.

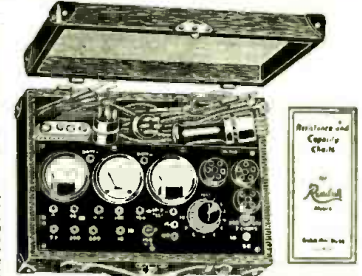

Model 710 Analyzer. List Price, \$27.50.
YOUR PRICE \$16.18

WE ARE A WHOLESALE HOUSE AND CAN NOT ACCEPT ORDERS FOR LESS THAN \$3.00. If C.O.D. shipment is desired, please remit 20% remittance, which must accompany all orders. If full cash accompanies order, deduct 2% discount (except on Readrite 710 Analyzer). Send money order—certified check—U. S. Stamps.

ORDER FROM THIS PAGE You will find special prices from time to time, in this magazine. Get our big FREE catalog for the greatest Radio Bargains. Should you wish goods shipped by parcel post, be sure to include sufficient extra remittance for same. Any excess will be refunded.

Radio Trading Company 102 Park Place New York, N. Y.

Whatever You Want in a Radio **WE GUARANTEE IT!**

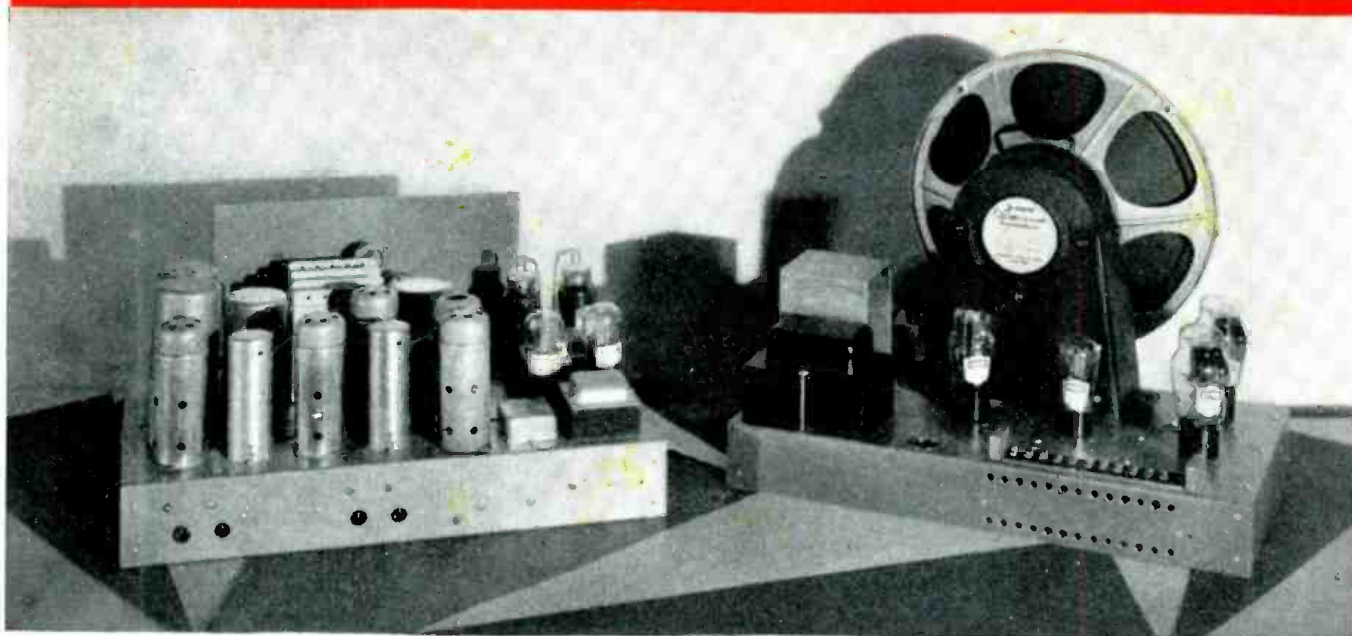

Do you want *actual* daily round-the-world reception? Or 95 stations on the broadcast dial? Or the simplest short-wave tuning of any radio? Or a "down-to-the-noise level" sensitivity and the hair line selectivity necessary for championship "stunt" reception? Or the most awe-inspiring tone you've ever heard? Or power enough to fill a cathedral?

Whatever it is you're looking for in a deluxe custom radio, you'll find it in the Howard 19-tube Explorer. *We guarantee it!*

That is possible only because the

Explorer comes from the Laboratory of the oldest manufacturer of radios in the world—the Laboratory which gave the radio industry the Multiple-Ganged Condenser, Metal Shielding, Automatic Volume Control, Built-in Power Supply. The Laboratory that pioneered the AC Dynamic Speaker, Wet Electrolytics, and Remote Control. In recent years they have developed Noise Suppression, and hold important patents on these circuits.

Some of the members of the Howard Laboratory have been there for more than ten years,

steadily building a small number of the highest quality receivers.

Howards have sold for as much as \$4,000 for a table model!

We haven't the space to give a complete laboratory analysis of the Explorer here. Fill in the coupon now for a free copy of the complete details.

SEND COUPON TODAY!

Howard Radio Company
South Haven, Michigan.

Please send me every detail on the
Howard Explorer.

Name

Address

Town State

HOWARD RADIO

SOUTH HAVEN • MICHIGAN

World's Oldest Manufacturers of Radio Receivers

I saved 1/2 by buying direct from the Midwest Laboratories

Yes, and it gives you WORLD-WIDE Reception!

Amazing New **SUPER Deluxe**

16-TUBE ALL-WAVE Radio

9 TO 2,000 METERS

30 DAYS FREE TRIAL



WRITE FOR NEW FREE CATALOG

BEFORE you buy any radio, write for this big new FREE Midwest catalog... printed in four colors. It has helped thousands of satisfied customers save from 1/3 to 1/2 on their radios... by buying direct from the Midwest Laboratories. You, too, can make a positive saving of 30% to 50% by buying a Midwest 16-tube deluxe ALL-WAVE radio at sensationally low direct-from-laboratory prices. You'll be amazed and delighted with its super performance! Broadcasts from stations 10,000 miles and more away are brought in... "clear as locals". You get complete wave length coverage of 9 to 2,000 meters (33 megacycles to 150 KC). Now, you can enjoy the new DX-ing hobby... and secure verifications from world's most distant stations.

These bigger, better, more powerful, clearer-toned, super-selective radios have FIVE distinct wave bands: ultra-short, short, medium, broadcast and long... putting the whole world of radio at your finger tips. Now listen in on all U. S. programs... Canadian, police, amateur, commercial, airplane and ship broadcasts... and programs from the four corners of the earth. Thrill to the chimes of Big Ben from GSB, at Daventry, England—tune in on the "Marseillaise" from FYA, Pointoise, France—hear sparkling music from EAQ, Madrid, Spain—listen to the call of the Kookaburra bird from VK2ME, Sydney, Australia—etc. Never before so much radio for so little money! Write for FREE catalog.

WORLD'S GREATEST RADIO VALUE

\$49.50 with New **Deluxe Auditorium Type SPEAKER**

... 40 NEW 1934 FEATURES ...

Try this Midwest radio... in your own home... for thirty days before you decide. See for yourself the 40 new 1934 features that insure amazing performance. Other features include: Automatic Select-O-Band, Amplified Automatic Volume Control, 16 New Type Tubes, Balanced Unit Superheterodyne Circuit, Velvety Action Tuning, Super-Power Class "A" Amplifier, 29 Tuned Circuits, New Duplex-Diode-High Mu Pentode Tubes, No-Image Heterodynes, Full Rubber Floated Chassis, Variable Tone Blender, Centralized Tuning, 7 KC Selectivity, New Thermionic Rectifier, Automatic Tone Compensation, Auditorium Type Speaker, etc. These features are usually found only in sets selling from \$100 to \$150.

AMAZING FOREIGN RECEPTION

AKRON, OHIO— My Midwest-16 is a real-getter for distance. Received 205 stations on regular wave band... including U.S., Canadian, Mexican, Cuban and Hawaiian stations. Also many police, airport and "ham" stations from all over the country. Have logged England, France, Germany, Madrid, Rome, on 15-30 meter band. South American stations include Venezuela, Colombia, Brazil, Yucatan.—L.H. MOELLER, 793 N. South St.

DEAL DIRECT WITH LABORATORIES

Increasing costs are sure to result in higher radio prices soon. Buy before the big advance... NOW, while you can take advantage of Midwest's amazingly low prices. No middlemen's profits to pay! You save from 30% to 50% when you buy direct from Midwest Laboratories... you get 30 days FREE trial—as little as \$5.00 down puts a Midwest radio in your home. Satisfaction guaranteed or your money back! FREE catalog shows sensational radio values. Write TODAY!

SAVE UP TO 50%

TERMS AS LOW AS \$5.00 DOWN

NEW STYLE CONSOLES

Write quickly for your FREE copy of the new Midwest catalog. It pictures a complete line of beautiful, artistic deluxe consoles and chassis... in four colors! Sensationally low prices save you 30% to 50%. Also shows performance curves that prove Midwest radios out-perform most of the \$150 sets. You can order your Midwest radio from this catalog with as much certainty of satisfaction as if you were to select it personally at our great radio laboratories. Write TODAY!

MAIL COUPON TODAY! FOR AMAZING 30-DAY FREE TRIAL OFFER AND NEW 1934 CATALOG

MIDWEST RADIO CORP.
Dept. 421
Cincinnati, Ohio.

Without obligation on my part send me your new FREE 1934 catalog, and complete details of your liberal 30-day FREE trial offer. This is NOT an order.

AGENTS! Make Easy Extra Money

Check Here for Details

Name.....
Address.....
City..... State.....

MIDWEST RADIO CORP.

DEPT. 421 - CINCINNATI, OHIO, U.S.A.

Established 1920 Cable Address Miraco ABC 5th Edition